



**SGS-CSTC Standards Technical Services Co., Ltd.
Shenzhen Branch**

No. 1 Workshop, M-10, Middle section, Science & Technology Park,
Shenzhen, Guangdong, China 518057

Telephone: +86 (0) 755 2601 2053
Fax: +86 (0) 755 2671 0594
Email: ee.shenzhen@sgs.com

Report No.: SZEM180400346101
Page: 1 of 35

TEST REPORT

Application No.: SZEM1804003461CR (SGS SZ No.: T51810220173EM)
Applicant: DOUBLEEAGLE INDUSTRY (CHINA) LIMITED
Address of Applicant: Xingda Industrial Park, Chenghai District, Shantou City, Guangdong Province, China
Manufacturer/ Supplier: DOUBLEEAGLE INDUSTRY (CHINA) LIMITED
Equipment Under Test (EUT):
EUT Name: Building Blocks
Item No.: Please refer to section 2 ♣
♣ Please refer to section 2 of this report which indicates which item was actually tested and which were electrically identical.
Country of Origin: China
Request Age Grading: 3+
Standard(s) : EN 301 489-1 V2.1.1
Final draft EN 301 489-3 V2.1.1
Date of Receipt: 2018-05-04
Date of Test: 2018-05-07 to 2018-05-10
Date of Issue: 2018-05-10

Test Result:	Pass*
---------------------	--------------

* In the configuration tested, the EUT complied with the standards specified above.

The CE mark as shown below can be used, under the responsibility of the manufacturer, after completion of an EU Declaration of Conformity and compliance with all relevant EU Directives.



Keny Xu
EMC Laboratory Manager

The manufacturer should ensure that all products in series production are in conformity with the product sample detailed in this report. If the product in this report is used in any configuration other than that detailed in the report, the manufacturer must ensure the new system complies with all relevant standards. Any mention of SGS International Electrical Approvals or testing done by SGS International Electrical Approvals in connection with, distribution or use of the product described in this report must be approved by SGS International Electrical Approvals in writing.

This document is issued by the Company subject to its General Conditions of Service printed overleaf, available on request or accessible at <http://www.sgs.com/en/Terms-and-Conditions.aspx> and, for electronic format documents, subject to Terms and Conditions for Electronic Documents at <http://www.sgs.com/en/Terms-and-Conditions/Terms-e-Documents.aspx>. Attention is drawn to the limitation of liability, indemnification and jurisdiction issues defined therein. Any holder of this document is advised that information contained hereon reflects the Company's findings at the time of its intervention only and within the limits of Client's instructions, if any. The Company's sole responsibility is to its Client and this document does not exonerate parties to a transaction from exercising all their rights and obligations under the transaction documents. This document cannot be reproduced except in full, without prior written approval of the Company. Any unauthorized alteration, forgery or falsification of the content or appearance of this document is unlawful and offenders may be prosecuted to the fullest extent of the law. Unless otherwise stated the results shown in this test report refer only to the sample(s) tested and such sample(s) are retained for 30 days only.



<i>Revision Record</i>				
<i>Version</i>	<i>Chapter</i>	<i>Date</i>	<i>Modifier</i>	<i>Remark</i>
01		2018-05-10		Original

Authorized for issue by:				
				
		<hr/>		
		Gebin Sun /Project Engineer		
				
		<hr/>		
		Eric Fu /Reviewer		

2 Test Summary

Emission Part				
Item	Standard	Method	Requirement	Result
Conducted Emissions at Mains Terminals (150kHz-30MHz)	EN 301 489-1 V2.1.1 Final draft EN 301 489-3 V2.1.1	EN 55032:2015	Class B	Pass
Radiated Emissions (30MHz-1GHz)	EN 301 489-1 V2.1.1 Final draft EN 301 489-3 V2.1.1	EN 55032:2015	Class B	Pass
Harmonic Current Emission	EN 301 489-1 V2.1.1 Final draft EN 301 489-3 V2.1.1	EN 61000-3-2:2014	Class A	Pass
Voltage Fluctuations and Flicker	EN 301 489-1 V2.1.1 Final draft EN 301 489-3 V2.1.1	EN 61000-3-3:2013	Clause 5 of EN 61000-3-3	Pass

Immunity Part				
Item	Standard	Method	Requirement	Result
Electrostatic Discharge	EN 301 489-1 V2.1.1 Final draft EN 301 489-3 V2.1.1	EN 61000-4-2:2009	4kV Contact Discharge 8kV Air Discharge	Pass
Electrical Fast Transients/Burst at Power Port	EN 301 489-1 V2.1.1 Final draft EN 301 489-3 V2.1.1	EN 61000-4-4:2012	1kV 5/50ns Tr/Td 5kHz Repetition Frequency	Pass
Surge at Power Port	EN 301 489-1 V2.1.1 Final draft EN 301 489-3 V2.1.1	EN 61000-4-5:2014	1.2/50µs Tr/Td 1kV Line to Line 2kV Line to Ground	Pass
Conducted Immunity at Power Port (150kHz-80MHz)	EN 301 489-1 V2.1.1 Final draft EN 301 489-3 V2.1.1	EN 61000-4-6:2014	3Vrms (emf),80%,1kHz Amp. Mod.	Pass
Voltage Dips and Interruptions	EN 301 489-1 V2.1.1 Final draft EN 301 489-3 V2.1.1	EN 61000-4-11:2004	0 % UT for 0.5per 0 % UT for 1per 0 % UT for 250per 70 % UT for 25per UT is Supply Voltage	Pass
Radiated Immunity (80MHz-6GHz)	EN 301 489-1 V2.1.1 Final draft EN 301 489-3 V2.1.1	EN 61000-4-3:2006 +A1:2008+A2:2010	3V/m, 80%, 1kHz Amp. Mod.	Pass



Remark:

Item No.: C51001W, C51002W, C51003W, C51004W, C51005W, C51006W, C51007W, C51008W, C51009W, C51010W, C51011W, C51012W, C51013W, C51014W, C51015W, C51016W, C51017W, C51018W, C51019W, C51020W, C51021W, C51022W, C51023W, C51024W, C51025W, C51026W, C51029W, C51030W, C51031W, C51032W, C51033W, C51034W, C51035W, C51036W, C51037W, C51038W, C51039W, C51040W, C52001W, C52002W, C52003W, C52004W, C52005W, C52006W, C52007W, C52008W, C52009W, C52010W, C52011W, C52012W, C52013W, C52014W, C52015W, C52016W, C52017W, C52018W, C52019W, C52020W, C53001W, C53002W

Only the item C51004W was tested, since the electrical circuit design, layout, components used, internal wiring and functions were identical for all the above items, only different on decorations, colour and item No..

3 Contents

	Page
1 COVER PAGE	1
2 TEST SUMMARY	3
3 CONTENTS	5
4 GENERAL INFORMATION	7
4.1 DETAILS OF E.U.T.	7
4.2 DESCRIPTION OF SUPPORT UNITS	7
4.3 MEASUREMENT UNCERTAINTY	7
4.4 TEST LOCATION.....	8
4.5 TEST FACILITY.....	8
4.6 DEVIATION FROM STANDARDS.....	8
4.7 ABNORMALITIES FROM STANDARD CONDITIONS	8
4.8 MONITORING OF EUT FOR ALL IMMUNITY TEST.....	8
5 EQUIPMENT LIST	9
6 EMISSION TEST RESULTS	12
6.1 CONDUCTED EMISSIONS AT MAINS TERMINALS (150kHz-30MHz).....	12
6.1.1 <i>E.U.T. Operation</i>	12
6.1.2 <i>Test Setup Diagram</i>	12
6.1.3 <i>Measurement Data</i>	12
6.2 RADIATED EMISSIONS (30MHz-1GHz).....	15
6.2.1 <i>E.U.T. Operation</i>	15
6.2.2 <i>Test Setup Diagram</i>	15
6.2.3 <i>Measurement Data</i>	15
6.3 HARMONIC CURRENT EMISSION	18
6.4 VOLTAGE FLUCTUATIONS AND FLICKER	19
6.4.1 <i>E.U.T. Operation</i>	19
6.4.2 <i>Test Setup Diagram</i>	19
6.4.3 <i>Measurement Data</i>	19
7 IMMUNITY TEST RESULTS	21
7.1 PERFORMANCE CRITERIA DESCRIPTION IN ETSI EN 301 489-1 V2.1.1	21
7.2 PERFORMANCE CRITERIA DESCRIPTION IN ETSI EN 301 489-3 V2.1.1	22
7.3 ELECTROSTATIC DISCHARGE	23
7.3.1 <i>Test Setup Diagram</i>	23
7.3.2 <i>E.U.T. Operation</i>	23
7.3.3 <i>Test Results:</i>	23
7.4 ELECTRICAL FAST TRANSIENTS/BURST AT POWER PORT	24
7.4.1 <i>Test Setup Diagram</i>	24
7.4.2 <i>E.U.T. Operation</i>	24
7.4.3 <i>Test Results:</i>	24
7.5 SURGE AT POWER PORT.....	25
7.5.1 <i>Test Setup Diagram</i>	25
7.5.2 <i>E.U.T. Operation</i>	25
7.5.3 <i>Test Results:</i>	25
7.6 CONDUCTED IMMUNITY AT POWER PORT (150kHz-80MHz).....	26
7.6.1 <i>Test Setup Diagram</i>	26



7.6.2	E.U.T. Operation	26
7.6.3	Test Results:	26
7.7	VOLTAGE DIPS AND INTERRUPTIONS	27
7.7.1	Test Setup Diagram	27
7.7.2	E.U.T. Operation	27
7.7.3	Test Results:	27
7.8	RADIATED IMMUNITY (80MHZ-6GHZ)	28
7.8.1	Test Setup Diagram	28
7.8.2	E.U.T. Operation	28
7.8.3	Test Results:	28
8	PHOTOGRAPHS	29
8.1	CONDUCTED EMISSIONS AT MAINS TERMINALS (150KHZ-30MHZ) TEST SETUP	29
8.2	RADIATED EMISSIONS (30MHZ-1GHZ) TEST SETUP	30
8.3	VOLTAGE FLUCTUATIONS AND FLICKER TEST SETUP	31
8.4	ELECTROSTATIC DISCHARGE TEST SETUP	32
8.5	ELECTRICAL FAST TRANSIENTS/BURST AT POWER PORT TEST SETUP	33
8.6	SURGE AT POWER PORT TEST SETUP	33
8.7	CONDUCTED IMMUNITY AT POWER PORT (150KHZ-80MHZ) TEST SETUP	34
8.8	VOLTAGE DIPS AND INTERRUPTIONS TEST SETUP	34
8.9	RADIATED IMMUNITY (80MHZ-6GHZ) TEST SETUP	35
8.10	EUT CONSTRUCTIONAL DETAILS (EUT PHOTOS)	35

4 General Information

4.1 Details of E.U.T.

Power supply:	3.0V DC(1.5V x 2 "AA" Size Batteries) for TX Rechargeable battery DC3.6V for RX
Cable:	USB Cable:60cm unshielded
The highest working frequency(except RF modulator):	Less than 108MHz
Operating Frequency:	2.4GHz(2405MHz-2475MHz)
Channel number:	71
Modulation Type:	GFSK
Sample Type:	Portable production
Antenna Type:	Integral
Antenna Gain:	0dBi

4.2 Description of Support Units

Description	Manufacturer	Model No.	Serial No.
AC/DC Adapter	SGS	DC 5V	REF. No.SEA0500

4.3 Measurement Uncertainty

No.	Item	Measurement Uncertainty
1	Conduction emission	3.45dB (9kHz to 150kHz)
		3.0dB (150kHz to 30MHz)
2	Radiated emission	4.5dB (30MHz-1GHz)
		4.8dB (1GHz-6GHz)
3	Radiated Immunity	1.64dB
4	Conducted Immunity	0.96dB
5	ESD	6 %
6	EFT (Electrical Fast Transients)	5 %
7	Surge Immunity	5 %
8	Voltage Dips and Interruptions	4 %
9	Temperature test	1 °C
10	Humidity test	3%
11	DC power test	0.5 %

4.4 Test Location

All tests were performed at:

SGS-CSTC Standards Technical Services Co., Ltd., Shenzhen Branch

No. 1 Workshop, M-10, Middle Section, Science & Technology Park, Shenzhen, Guangdong, China.
518057.

Tel: +86 755 2601 2053 Fax: +86 755 2671 0594

No tests were sub-contracted.

4.5 Test Facility

The test facility is recognized, certified, or accredited by the following organizations:

- **CNAS (No. CNAS L2929)**

CNAS has accredited SGS-CSTC Standards Technical Services Co., Ltd. Shenzhen Branch EMC Lab to ISO/IEC 17025:2005 General Requirements for the Competence of Testing and Calibration Laboratories (CNAS-CL01 Accreditation Criteria for the Competence of Testing and Calibration Laboratories) for the competence in the field of testing.

- **A2LA (Certificate No. 3816.01)**

SGS-CSTC Standards Technical Services Co., Ltd., Shenzhen EMC Laboratory is accredited by the American Association for Laboratory Accreditation(A2LA). Certificate No. 3816.01.

- **VCCI**

The 3m Fully-anechoic chamber for above 1GHz, 10m Semi-anechoic chamber for below 1GHz, Shielded Room for Mains Port Conducted Interference Measurement and Telecommunication Port Conducted Interference Measurement of SGS-CSTC Standards Technical Services Co., Ltd. have been registered in accordance with the Regulations for Voluntary Control Measures with Registration No.: G-20026, R-14188, C-12383 and T-11153 respectively.

- **FCC –Designation Number: CN1178**

SGS-CSTC Standards Technical Services Co., Ltd., Shenzhen EMC Laboratory has been recognized as an accredited testing laboratory.

Designation Number: CN1178. Test Firm Registration Number: 406779.

- **Industry Canada (IC)**

Two 3m Semi-anechoic chambers and the 10m Semi-anechoic chamber of SGS-CSTC Standards Technical Services Co., Ltd. Shenzhen Branch EMC Lab have been registered by Certification and Engineering Bureau of Industry Canada for radio equipment testing with Registration No.: 4620C-1, 4620C-2, 4620C-3.

4.6 Deviation from Standards

None

4.7 Abnormalities from Standard Conditions

None

4.8 Monitoring of EUT for All Immunity Test

Visual: Monitored the connection status of the EUT

Audio: None

5 Equipment List

Conducted Emissions at Mains Terminals (150kHz-30MHz)					
Equipment	Manufacturer	Model No	Inventory No	Cal Date	Cal Due Date
Shielding Room	ChangZhou ZhongYu	GB-88	SEM001-06	2017-05-10	2020-05-09
Measurement Software	AUDIX	e3 V5.4.1221d	N/A	N/A	N/A
Coaxial Cable	SGS	N/A	SEM024-01	2017-07-13	2018-07-12
LISN	Rohde & Schwarz	ENV216	SEM007-01	2017-09-27	2018-09-26
LISN	ETS-LINDGREN	3816/2	SEM007-02	2018-04-02	2019-04-01
EMI Test Receiver	Rohde & Schwarz	ESCI	SEM004-02	2018-04-02	2019-04-01

Radiated Emissions (30MHz-1GHz)					
Equipment	Manufacturer	Model No	Inventory No	Cal Date	Cal Due Date
3m Semi-Anechoic Chamber	ETS-LINDGREN	N/A	SEM001-01	2017-08-05	2020-08-04
Measurement Software	AUDIX	e3 V8.2014-6-27	N/A	N/A	N/A
Coaxial Cable	SGS	N/A	SEM025-01	2017-07-13	2018-07-12
EMI Test Receiver	Agilent Technologies	N9038A	SEM004-05	2017-09-27	2018-09-26
BiConiLog Antenna (26-3000MHz)	ETS-LINDGREN	3142C	SEM003-01	2017-06-27	2020-06-26
Pre-amplifier (0.1-1300MHz)	Agilent Technologies	8447D	SEM005-01	2018-04-02	2019-04-01

Voltage Fluctuations and Flicker					
Equipment	Manufacturer	Model No	Inventory No	Cal Date	Cal Due Date
AC Power Source	California Instruments	5001ix	SEM016-02	2018-04-13	2019-04-12
Power Analyzer	California Instruments	PACS-1	SEM016-01	2018-04-13	2019-04-12
Measurement Software	California Instruments	CTS 3.0 V3.2.0.6	N/A	N/A	N/A

Electrostatic Discharge					
Equipment	Manufacturer	Model No	Inventory No	Cal Date	Cal Due Date
ESD Ground Plane	SGS(3m*3m)	N/A	SEN006-01	N/A	N/A
ESD Generator	TESEQ AG	NSG 437	SEM019-02	2018-04-16	2019-04-15

Electrical Fast Transients/Burst at Power Port					
Equipment	Manufacturer	Model No	Inventory No	Cal Date	Cal Due Date
Ultra Compact Simulator	EM TEST	UCS 500N7	SEM018-02	2018-04-13	2019-04-12
Measurement Software	EM TEST	IEC CONTROL V6.0.1	N/A	N/A	N/A



Surge at Power Port					
Equipment	Manufacturer	Model No	Inventory No	Cal Date	Cal Due Date
Ultra Compact Simulator	EM TEST	UCS 500N7	SEM018-02	2018-04-13	2019-04-12
Measurement Software	EM TEST	IEC CONTROL V6.0.1	N/A	N/A	N/A

Conducted Immunity at Power Port (150kHz-80MHz)					
Equipment	Manufacturer	Model No	Inventory No	Cal Date	Cal Due Date
Shielding Room	AUDIX	N/A	SEM001-08	2017-05-10	2020-05-10
RF-Generator	SCHAFFNER	NSG 2070	SEM006-01	2017-09-27	2018-09-26
Coupling/Decoupling Network	SCHAFFNER	CDN M016	SEM007-03	2018-05-07	2019-05-06
Conditioning Amplifier	Brüel & Kjaer	2690-OS2	SEM005-10	2018-04-20	2019-04-19
Audio Analyzer	Rohde & Schwarz	UPV	SEM008-03	2017-09-27	2018-09-26

Voltage Dips and Interruptions					
Equipment	Manufacturer	Model No	Inventory No	Cal Date	Cal Due Date
Ultra Compact Simulator	EM TEST	UCS 500N7	SEM018-02	2018-04-13	2019-04-12
Measurement Software	EM TEST	IEC CONTROL V6.0.1	N/A	N/A	N/A

Radiated Immunity (80MHz-6GHz)					
Equipment	Manufacturer	Model No	Inventory No	Cal Date	Cal Due Date
Fully-Anechoic Chamber 2	Chang Zhou Zhong Shuo	854	SEM001-05	2017-05-10	2020-05-09
Measurement Software	Rohde & Schwarz	EMC32 V9.25.00	N/A	N/A	N/A
Signal Generator	Rohde & Schwarz	SMB100A	SEM006-11	2018-04-02	2019-04-01
Broadband Amplifier(80MHz-1GHz)	Rohde & Schwarz	BBA150-BC250	SEM005-12	2017-09-27	2018-09-26
Broadband Amplifier(800MHz-3GHz)	Rohde & Schwarz	BBA150-D110	SEM005-13	2018-04-02	2019-04-01
Broadband Amplifier(2.5GHz-6GHz)	Rohde & Schwarz	BBA150-E60	SEM005-16	2018-04-13	2019-04-12
Power Sensor	Rohde & Schwarz	NRP-Z91	SEM009-09	2018-04-02	2019-04-01
Stacked Log.-Per.-Antenna(70MHz-10GHz)	Schwarzbeck	STLP 9129	SEM003-25	N/A	N/A
Amplifier(10kHz-250MHz)	Amplifier Research	75A250A	SEM005-11	2018-04-02	2019-04-01
Universal Radio Communication Tester	Rohde & Schwarz	CMU 200	SEM010-01	2017-09-27	2018-09-26



**SGS-CSTC Standards Technical Services Co., Ltd.
Shenzhen Branch**

Report No.: SZEM180400346101

Page: 11 of 35

Universal Radio Communication Tester	Rohde & Schwarz	CMW 500	SEM010-03	2018-04-02	2019-04-01
Conditioning Amplifier	Brüel & Kjaer	2690-OS2	SEM005-10	2018-04-20	2019-04-19
Mouth Simulator	Brüel & Kjaer	4227	SEM017-01	2018-04-10	2019-04-09
Signal Source	Brüel & Kjaer	4231	SEM017-02	2018-04-14	2019-04-13
Audio Analyzer	Rohde & Schwarz	UPV	SEM008-03	2017-09-27	2018-09-26

General used equipment					
Equipment	Manufacturer	Model No	Inventory No	Cal Date	Cal Due Date
Humidity/ Temperature Indicator	Shanghai Meteorological Industry Factory	ZJ1-2B	SEM002-03	2017-09-29	2018-09-28
Humidity/ Temperature Indicator	Shanghai Meteorological Industry Factory	ZJ1-2B	SEM002-04	2017-09-29	2018-09-28
Humidity/ Temperature Indicator	Mingle	N/A	SEM002-08	2017-09-29	2018-09-28
Barometer	Changchun Meteorological Industry Factory	DYM3	SEM002-01	2018-04-08	2019-04-07

6 Emission Test Results

6.1 Conducted Emissions at Mains Terminals (150kHz-30MHz)

Test Requirement:	EN 301 489-1 V2.1.1
Test Method:	EN 55032:2015
Frequency Range:	150kHz to 30MHz
Limit:	
0.15M-0.5MHz	66dB(μV)-56dB(μV) quasi-peak, 56dB(μV)-46dB(μV) average
0.5M-5MHz	56dB(μV) quasi-peak, 46dB(μV) average
5M-30MHz	60dB(μV) quasi-peak, 50dB(μV) average
Detector:	Peak for pre-scan (9kHz resolution bandwidth) 0.15M to 30MHz

6.1.1 E.U.T. Operation

Operating Environment:

Temperature: 22 °C Humidity: 53.9 % RH Atmospheric Pressure: 1020 mbar

Pretest these modes to find the worst case: b:Charging mode,Keep the battery of the EUT in charging mode.

c:Idle mode,keep EUT standby.

The worst case for final test: b:Charging mode,Keep the battery of the EUT in charging mode.

6.1.2 Test Setup Diagram

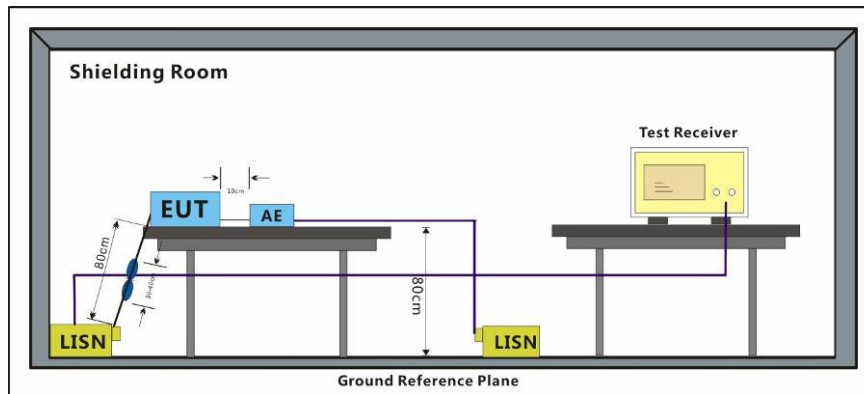

6.1.3 Measurement Data

An initial pre-scan was performed with peak detector. Quasi-Peak or Average measurement were performed at the frequencies with maximized peak emission were detected.

Mode:b; Line:Live Line

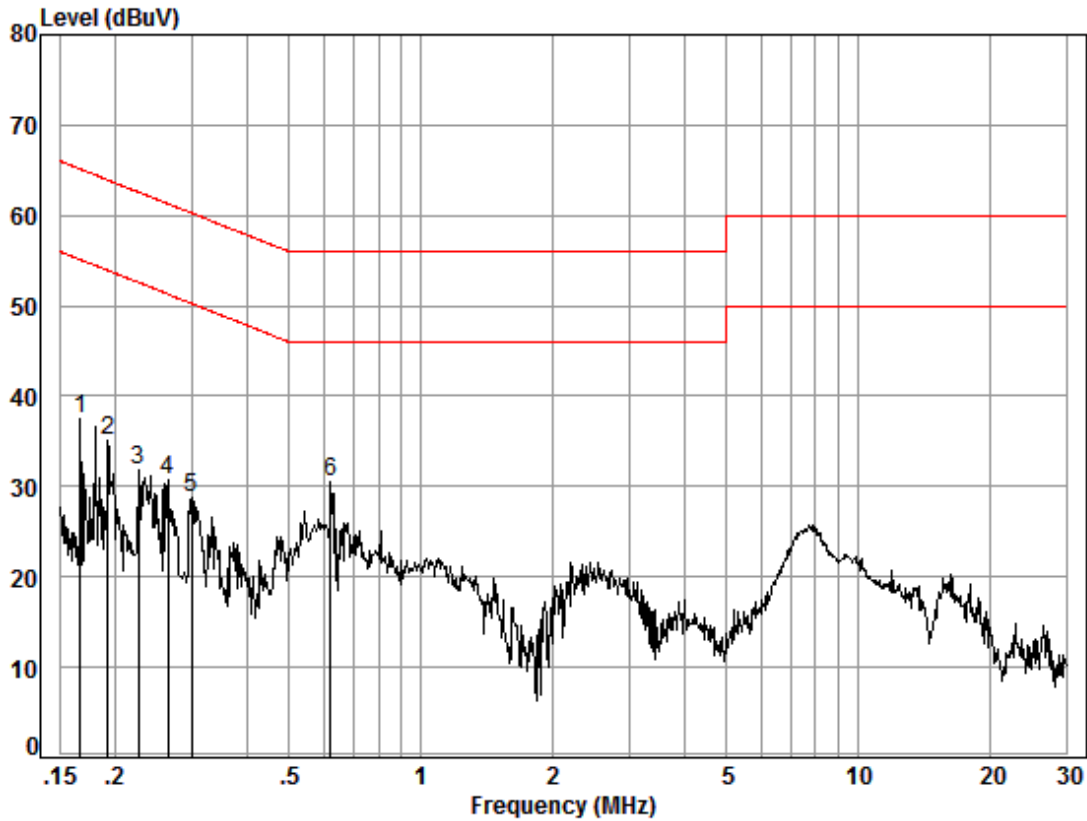

Site : Shielding Room
 Condition: Line
 Job No. : 03461CR
 Test mode: b

	Freq	Cable Loss	LISN Factor	Read Level	Limit Level	Limit Line	Over Limit	Remark
	MHz	dB	dB	dBuV	dBuV	dBuV	dB	
1	0.17	0.02	9.52	27.90	37.44	55.12	-17.68	Peak
2	0.19	0.02	9.50	25.68	35.20	53.93	-18.73	Peak
3	0.23	0.02	9.51	22.37	31.90	52.61	-20.71	Peak
4	0.26	0.01	9.51	21.28	30.80	51.29	-20.49	Peak
5	0.30	0.01	9.51	19.23	28.75	50.28	-21.53	Peak
6	0.62	0.02	9.52	20.99	30.53	46.00	-15.47	Peak

Mode:b; Line:Neutral Line

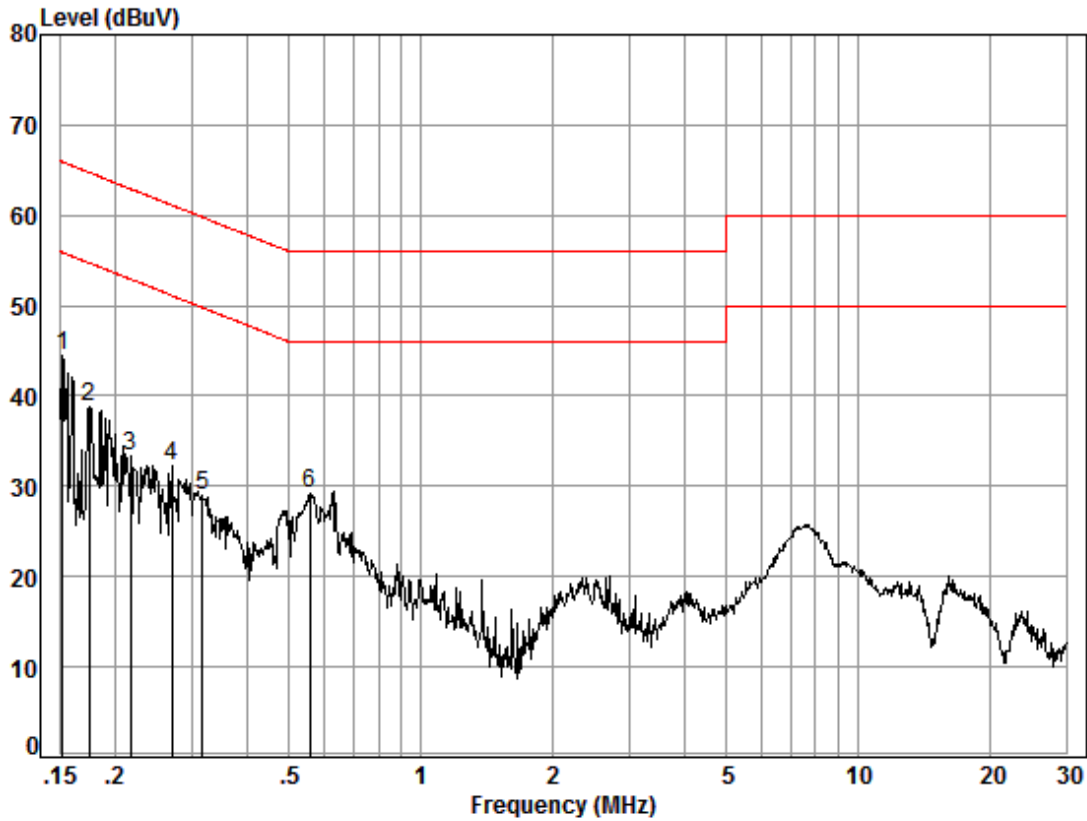

Site : Shielding Room
 Condition: Neutral
 Job No. : 03461CR
 Test mode: b

	Freq	Cable Loss	LISN Factor	Read Level	Limit Level	Limit Line	Over Limit	Remark
	MHz	dB	dB	dBuV	dBuV	dBuV	dB	
1	0.15	0.02	9.58	34.95	44.55	55.91	-11.36	Peak
2	0.17	0.02	9.59	29.28	38.89	54.77	-15.88	Peak
3	0.22	0.02	9.57	23.78	33.37	52.92	-19.55	Peak
4	0.27	0.01	9.58	22.64	32.23	51.12	-18.89	Peak
5	0.32	0.01	9.58	19.51	29.10	49.80	-20.70	Peak
6	0.56	0.01	9.61	19.51	29.13	46.00	-16.87	Peak

6.2 Radiated Emissions (30MHz-1GHz)

Test Requirement:	EN 301 489-1 V2.1.1
Test Method:	EN 55032:2015
Frequency Range:	30MHz to 1GHz
Measurement Distance:	3m
Limit:	
30MHz-230MHz	40 dB(μV/m) quasi-peak
230MHz-1GHz	47 dB(μV/m) quasi-peak
Detector:	Peak for pre-scan (120kHz resolution bandwidth) 30M to 1000MHz

6.2.1 E.U.T. Operation

Operating Environment:

Temperature: 23.6 °C Humidity: 53.2 % RH Atmospheric Pressure: 1020 mbar

Pretest these modes to find the worst case:

- a: Wireless mode, Keep the EUT pairing and working at high channel.
- b: Charging mode, Keep the battery of the EUT in charging mode.
- c: Idle mode, keep EUT standby.

The worst case for final test: a: Wireless mode, Keep the EUT pairing and working at high channel.

6.2.2 Test Setup Diagram

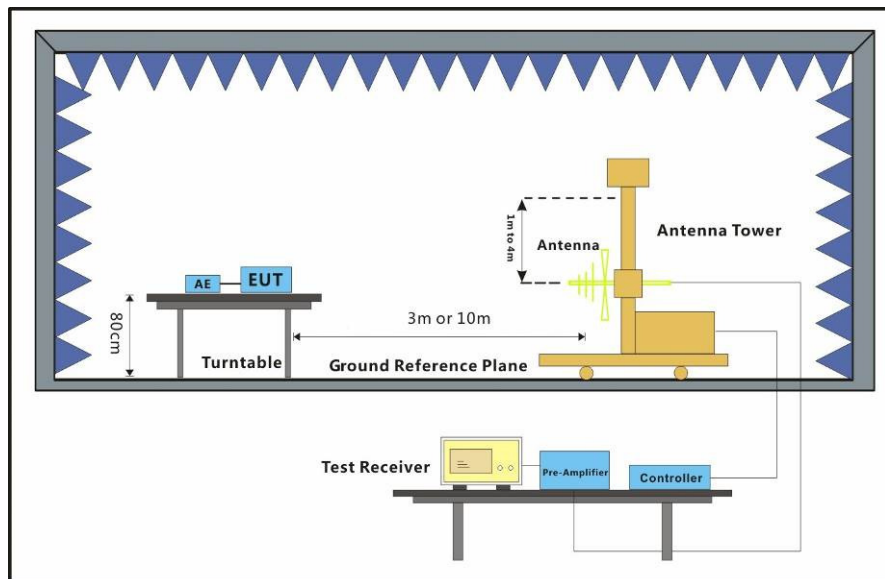

6.2.3 Measurement Data

An initial pre-scan was performed in the chamber using the spectrum analyser in peak detection mode. Quasi-peak measurements were conducted based on the peak sweep graph. The EUT was measured by BiConiLog antenna with 2 orthogonal polarities.



Mode:a; Polarization:Horizontal

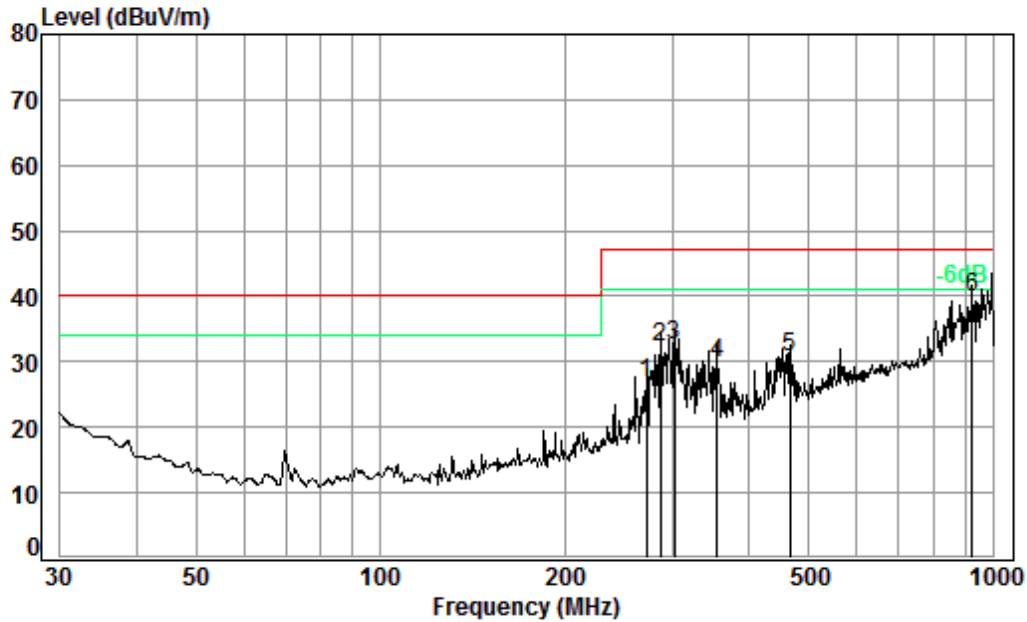

Condition: 3m HORIZONTAL
Job No. : 03461CR
: a

	Freq	Cable Loss	Ant Factor	Preamp Factor	Read Level	Level	Limit	Over
	MHz	dB	dB/m	dB	dBuV	dBuV/m	dBuV/m	dB
1	272.28	1.78	18.91	27.54	33.71	26.86	47.00	-20.14
2	286.98	1.84	19.09	27.54	38.85	32.24	47.00	-14.76
3	302.48	1.91	19.68	27.55	38.51	32.55	47.00	-14.45
4	354.18	2.07	21.22	27.65	34.25	29.89	47.00	-17.11
5	465.60	2.47	23.90	27.83	32.15	30.69	47.00	-16.31
6 pp	925.76	3.63	29.93	26.99	33.21	39.78	47.00	-7.22



Mode:a; Polarization:Vertical

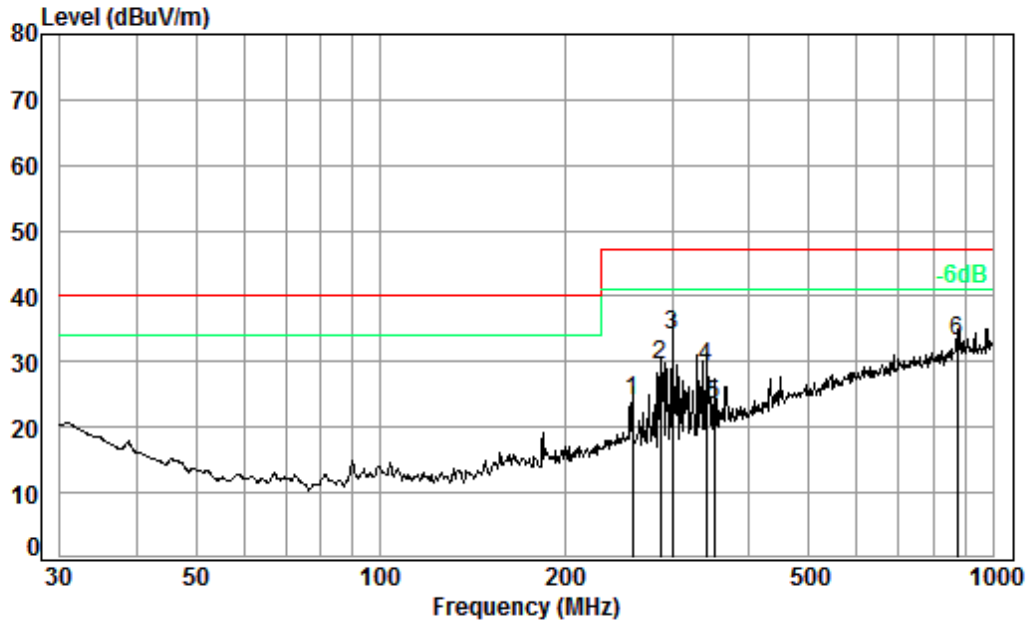

Condition: 3m VERTICAL
Job No. : 03461CR
: a

	Freq	Cable Loss	Ant Factor	Preamp Factor	Read Level	Level	Limit	Over
	MHz	dB	dB/m	dB	dBuV	dBuV/m	dBuV/m	dB
1	258.33	1.71	19.08	27.54	30.85	24.10	47.00	-22.90
2	286.98	1.84	19.09	27.54	36.02	29.41	47.00	-17.59
3 pp	299.32	1.90	19.57	27.54	40.14	34.07	47.00	-12.93
4	340.78	2.03	20.84	27.62	34.03	29.28	47.00	-17.72
5	350.48	2.06	21.11	27.64	27.94	23.47	47.00	-23.53
6	875.25	3.51	29.49	27.16	27.28	33.12	47.00	-13.88



6.3 Harmonic Current Emission

Test Requirement: EN 301 489-1 V2.1.1

Test Method: EN 61000-3-2:2014

Frequency Range: 100Hz to 2kHz

There is no need for Harmonics test to be performed on this product (rated power is less than 75W) in accordance with EN 61000-3-2:2014.

For further details, please refer to Clause 7 of EN 61000-3-2 which states:

"For the following categories of equipment, limits are not specified in this standard.- equipment with a rated power of 75W or less, other than lighting equipment."

6.4 Voltage Fluctuations and Flicker

Test Requirement: EN 301 489-1 V2.1.1

Test Method: EN 61000-3-3:2013

6.4.1 E.U.T. Operation

Operating Environment:

Temperature: 24.6 °C Humidity: 55.3 % RH Atmospheric Pressure: 1020 mbar

Pretest these modes to find the worst case: b:Charging mode,Keep the battery of the EUT in charging mode.

c:Idle mode,keep EUT standby.

The worst case for final test: b:Charging mode,Keep the battery of the EUT in charging mode.

6.4.2 Test Setup Diagram

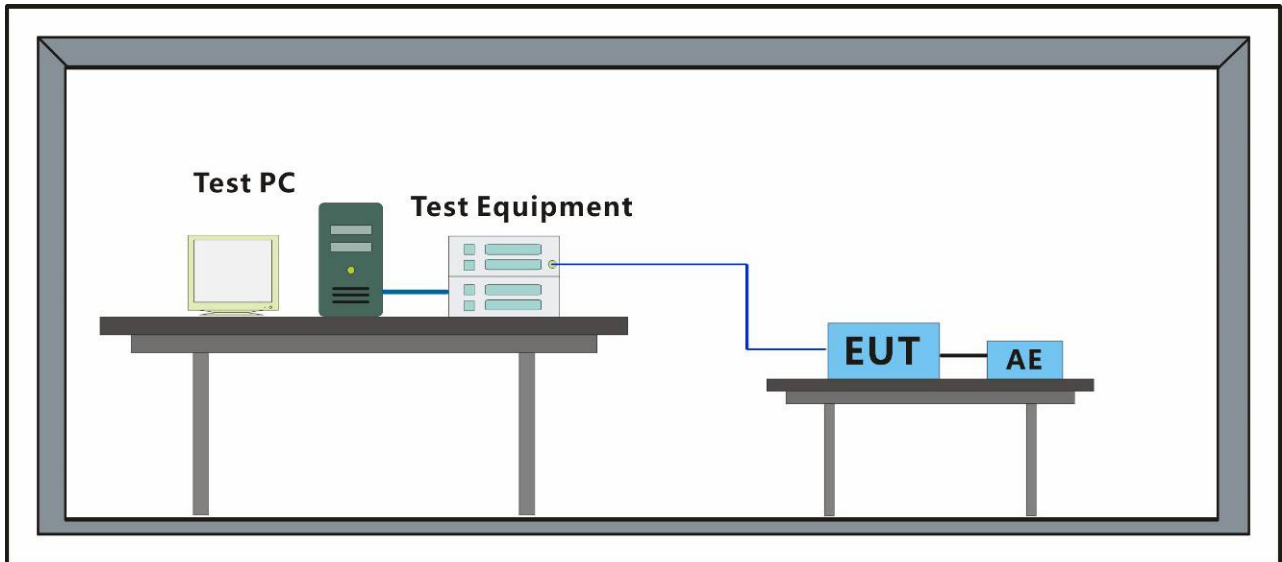

6.4.3 Measurement Data



Mode:b

Test Result: Pass

Status: Test Completed

Pst_i and limit line

European Limits

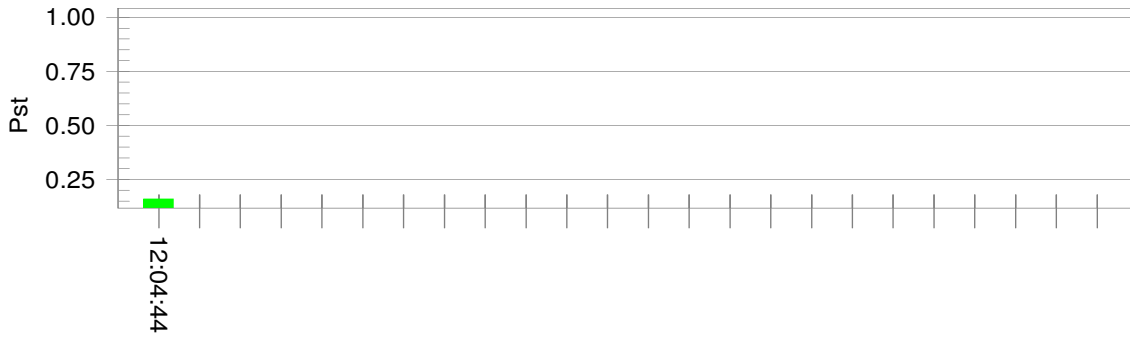

Plt and limit line



Parameter values recorded during the test:

Vrms at the end of test (Volt):	230.20		
Highest dt (%):	0.00	Test limit (%):	3.30 Pass
Time(mS) > dt:	0.0	Test limit (mS):	500.0 Pass
Highest dc (%):	0.00	Test limit (%):	3.30 Pass
Highest dmax (%):	0.00	Test limit (%):	4.00 Pass
Highest Pst (10 min. period):	0.160	Test limit:	1.000 Pass

7 Immunity Test Results

7.1 Performance Criteria Description in EN 301 489-1 V2.1.1

<p>Performance criteria for continuous phenomena applied to transmitters and receivers</p>	<p>During and after the test, the equipment shall continue to operate as intended. No degradation of performance or loss of function is allowed below a permissible performance level specified by the manufacturer when the equipment is used as intended. In some cases this permissible performance level may be replaced by a permissible loss of performance.</p> <p>During the test, the EUT shall not unintentionally transmit or change its actual operating state and stored data.</p> <p>If the minimum performance level or the permissible performance loss is not specified by the manufacturer, then either of these may be deduced from the product description and documentation and what the user may reasonably expect from the equipment if used as intended.</p>
<p>Performance criteria for transient phenomena applied to transmitters and receivers</p>	<p>For surges applied to symmetrically operated wired network ports intended to be connected directly to outdoor lines the following criteria applies:</p> <ul style="list-style-type: none"> • For products with only one symmetrical port intended for connection to outdoor lines, loss of function is allowed, provided the function is self-recoverable, or can be restored by the operation of the controls by the user in accordance with the manufacturer's instructions. A SW reboot is not allowed. Information stored in non-volatile memory, or protected by a battery backup, shall not be lost. • For products with more than one symmetrical port intended for connection to outdoor lines, loss of function on the port under test is allowed, provided the function is self-recoverable. A SW reboot is not allowed. Information stored in non-volatile memory, or protected by a battery backup, shall not be lost. <p>For all other ports the following applies:</p> <ul style="list-style-type: none"> • After the test, the equipment shall continue to operate as intended. No degradation of performance or loss of function is allowed below a permissible performance level specified by the manufacturer, when the equipment is used as intended. In some cases this permissible performance level may be replaced by a permissible loss of performance. • During the EMC exposure to an electromagnetic phenomenon, a degradation of performance is, however, allowed. No change of the actual mode of operation (e.g. unintended transmission) or stored data is allowed. • If the minimum performance level or the permissible performance loss is not specified by the manufacturer, then either of these may be deduced from the product description and documentation and what the user may reasonably expect from the equipment if used as intended.
<p>Performance criteria for equipment which does not provide a continuous communication link</p>	<p>For radio equipment which does not provide a continuous communication link, the manufacturer shall declare, for inclusion in the test report, his own specification for an acceptable level of performance or degradation of performance during and/or after the immunity tests. The performance specification shall be included in the product description and documentation.</p>



Performance criteria for ancillary equipment tested on a stand alone basis	If ancillary equipment is intended to be tested on a stand alone basis, the manufacturer shall declare, for inclusion in the test report, his own specification for an acceptable level of performance or degradation of performance during and/or after the immunity tests. The performance specification shall be included in the product description and documentation.
---	--

7.2 Performance Criteria Description in Final Draft EN 301 489-3 V2.1.1

Criteria	During Test	After Test
A	Operate as intended No loss of function No unintentional responses	Operate as intended No loss of function No degradation of performance No loss of stored data or user programmable functions
B	May show loss of function No unintentional responses	Operate as intended Lost function(s) shall be self-recoverable No degradation of performance No loss of stored data or user programmable functions

7.3 Electrostatic Discharge

Test Requirement: EN 301 489-1 V2.1.1
 Test Method: EN 61000-4-2:2009
 Performance Criterion: B
 Discharge Impedance: 330Ω/150pF
 Number of Discharge: Minimum 10 times at each test point
 Discharge Mode: Single Discharge
 Discharge Period: 1 second minimum

7.3.1 Test Setup Diagram

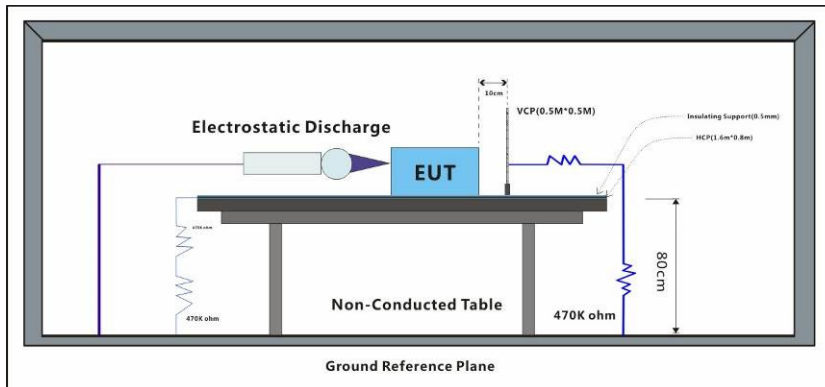

7.3.2 E.U.T. Operation

Operating Environment:
 Temperature: 24.4 °C Humidity: 45 % RH Atmospheric Pressure: 1020 mbar
 Test mode:
 a: Wireless mode, Keep the EUT pairing and working at high channel.
 b: Charging mode, Keep the battery of the EUT in charging mode.
 c: Idle mode, keep EUT standby.

7.3.3 Test Results:

- Observations: Test Point:
1. All insulated enclosure and seams.
 2. All accessible metal parts of the enclosure.
 3. All side

Discharge type	Level (kV)	Polarity	Test Point	Result / Observations
Air Discharge	2,4,8	+	1	A
Air Discharge	2,4,8	-	1	A
Contact Discharge	4	+	2	A
Contact Discharge	4	-	2	A
Horizontal Coupling	4	+	3	A
Horizontal Coupling	4	-	3	A
Vertical Coupling	4	+	3	A
Vertical Coupling	4	-	3	A

Results:

A: No degradation in the performance of the EUT was observed.

7.4 Electrical Fast Transients/Burst at Power Port

Test Requirement: EN 301 489-1 V2.1.1
 Test Method: EN 61000-4-4:2012
 Performance Criterion: B
 Repetition Frequency: 5kHz
 Burst Period: 300ms

7.4.1 Test Setup Diagram

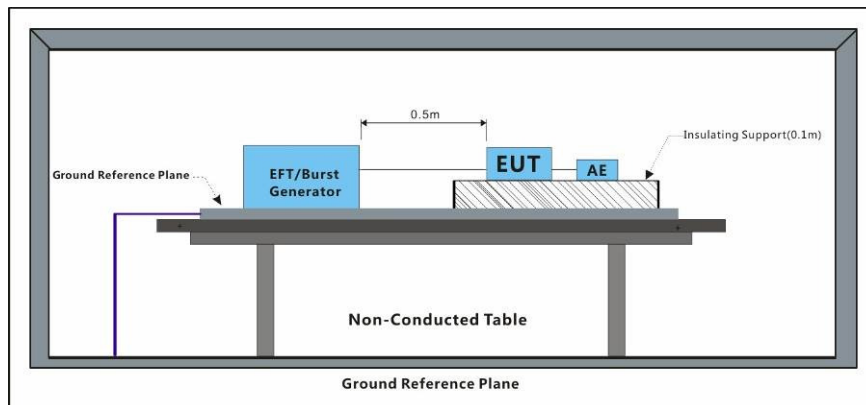

7.4.2 E.U.T. Operation

Operating Environment:
 Temperature: 24.6 °C Humidity: 55.5 % RH Atmospheric Pressure: 1020 mbar
 Test mode: b:Charging mode,Keep the battery of the EUT in charging mode.

7.4.3 Test Results:

Test Line	Level (kV)	Polarity	CDN/Clamp	Result / Observations
AC power port	1	+	CDN	A
AC power port	1	-	CDN	A

Results:

A: No degradation in the performance of the EUT was observed.

7.5 Surge at Power Port

Test Requirement: EN 301 489-1 V2.1.1
 Test Method: EN 61000-4-5:2014
 Performance Criterion: B
 Interval: 60s between each surge
 No. of surges: 5 positive, 5 negative at 0°, 90°, 180°, 270°.

7.5.1 Test Setup Diagram

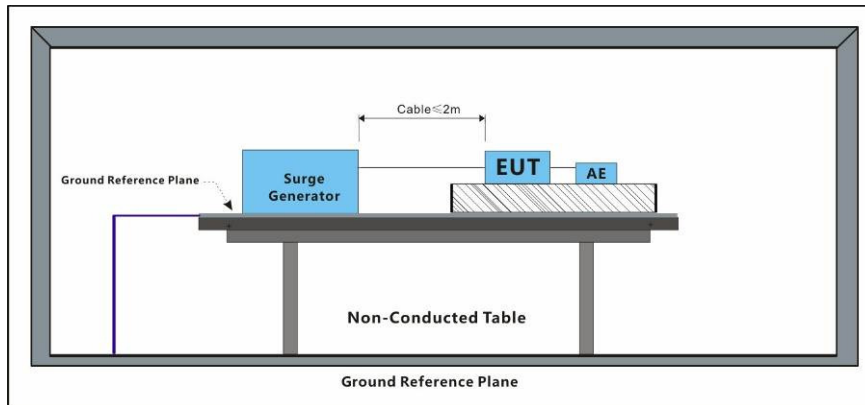

7.5.2 E.U.T. Operation

Operating Environment:
 Temperature: 24.6 °C Humidity: 55.5 % RH Atmospheric Pressure: 1020 mbar
 Test mode: b:Charging mode, Keep the battery of the EUT in charging mode.

7.5.3 Test Results:

Test Line	Level (kV)	Polarity	Phase (deg)	Result / Observations
L-N	1	+	0°	A
L-N	1	-	0°	A
L-N	1	+	90°	A
L-N	1	-	90°	A
L-N	1	+	180°	A
L-N	1	-	180°	A
L-N	1	+	270°	A
L-N	1	-	270°	A

Results:

A: No degradation in the performance of the EUT was observed.

7.6 Conducted Immunity at Power Port (150kHz-80MHz)

Test Requirement: EN 301 489-1 V2.1.1
 Test Method: EN 61000-4-6:2014
 Performance Criterion: A
 Frequency Range: 0.15MHz to 80MHz
 Modulation: 80%, 1kHz Amplitude Modulation
 Step Size: 1%

7.6.1 Test Setup Diagram

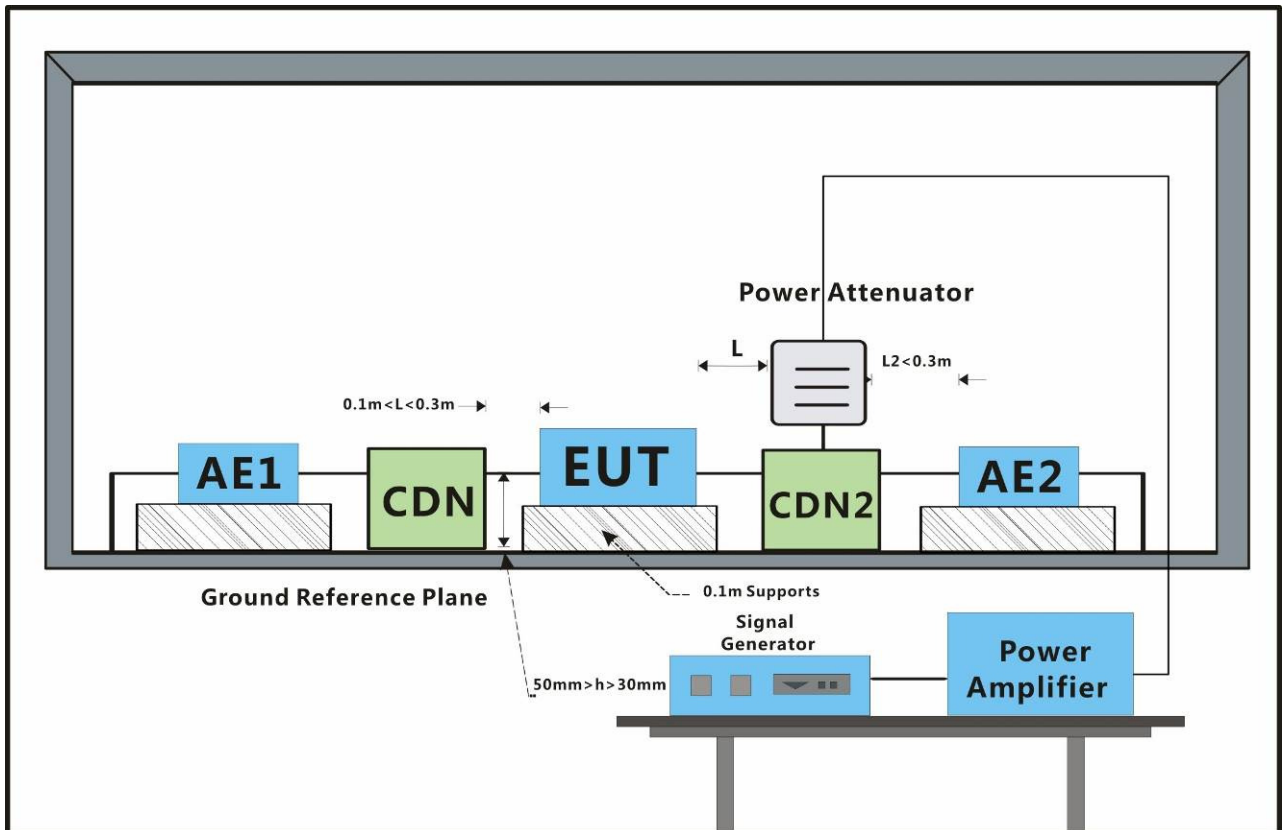

7.6.2 E.U.T. Operation

Operating Environment:
 Temperature: 24.6 °C Humidity: 55.1 % RH Atmospheric Pressure: 1020 mbar
 Test mode: b:Charging mode,Keep the battery of the EUT in charging mode.

7.6.3 Test Results:

Cable port	Level (Vrms)	CDN/Clamp	Dwell time	Result / Observations
AC power port	3	CDN	2s	A

Results:

A: No degradation in the performance of the EUT was observed.

7.7 Voltage Dips and Interruptions

Test Requirement: EN 301 489-1 V2.1.1
 Test Method: EN 61000-4-11:2004
 Performance Criterion: 0% of UT (Supply Voltage) for 0.5 Periods:B; 0% of UT for 250 Periods:C; 70 % of UT for 25 Periods:C
 No. of Dips / Interruptions: 3 per Level
 Time between dropout 10s

7.7.1 Test Setup Diagram

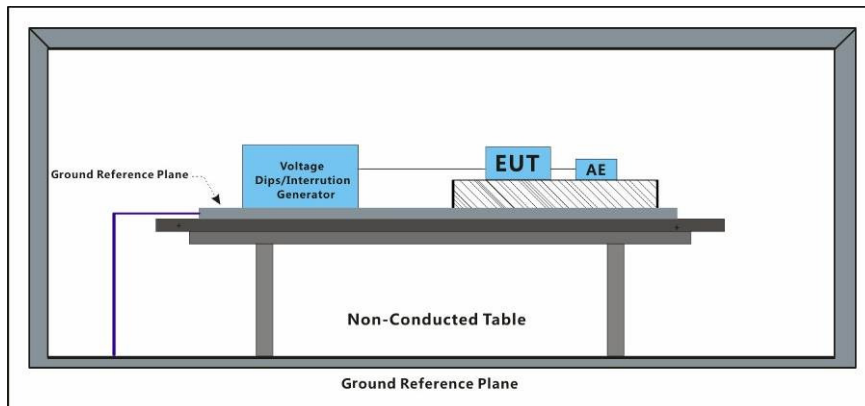

7.7.2 E.U.T. Operation

Operating Environment:
 Temperature: 24.6 °C Humidity: 55 % RH Atmospheric Pressure: 1020 mbar
 Test mode: b:Charging mode,Keep the battery of the EUT in charging mode.

7.7.3 Test Results:

Level % UT	Phase (deg)	Duration	No. of Dips / Interruptions	Result / Observations
0	0°	0.5 Cycles	3	A
0	180°	0.5 Cycles	3	A
0	0°	250 Cycles	3	B
0	180°	250 Cycles	3	B
70	0°	25 Cycles	3	A
70	180°	25 Cycles	3	A

Results:

A: No degradation in the performance of the EUT was observed.

B: The EUT stops charging during the test,but can recover automatically after the test.

7.8 Radiated Immunity (80MHz-6GHz)

Test Requirement: EN 301 489-1 V2.1.1
 Test Method: EN 61000-4-3:2006 +A1:2008+A2:2010
 Performance Criterion: A
 Frequency Range: 80MHz to 6GHz
 Antenna Polarisation: Vertical and Horizontal
 Modulation: 1kHz,80% Amp. Mod,1% increment

7.8.1 Test Setup Diagram

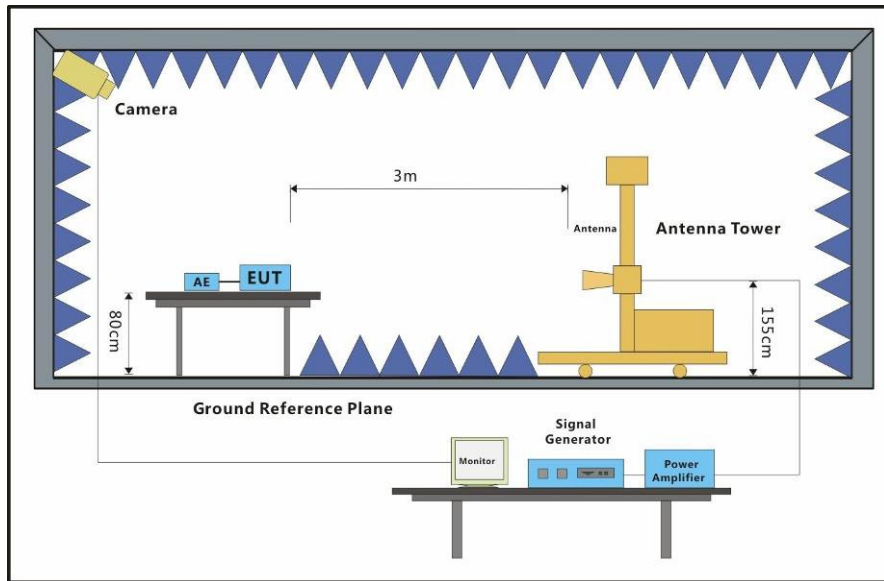

7.8.2 E.U.T. Operation

Operating Environment:
 Temperature: 23 °C Humidity: 56 % RH Atmospheric Pressure: 1020 mbar
 Test mode:
 a:Wireless mode,Keep the EUT pairing and working at high channel.
 b:Charging mode,Keep the battery of the EUT in charging mode.
 c:Idle mode,keep EUT standby.

7.8.3 Test Results:

Frequency	Level (V/m)	EUT Face	Dwell time	Result / Observations
80MHz-6GHz	3	Front	2s	A
80MHz-6GHz	3	Back	2s	A
80MHz-6GHz	3	Left	2s	A
80MHz-6GHz	3	Right	2s	A
80MHz-6GHz	3	Top	2s	A
80MHz-6GHz	3	Underside	2s	A

Results:

A: No degradation in the performance of the EUT was observed.

8 Photographs

8.1 Conducted Emissions at Mains Terminals (150kHz-30MHz) Test Setup



8.2 Radiated Emissions (30MHz-1GHz) Test Setup

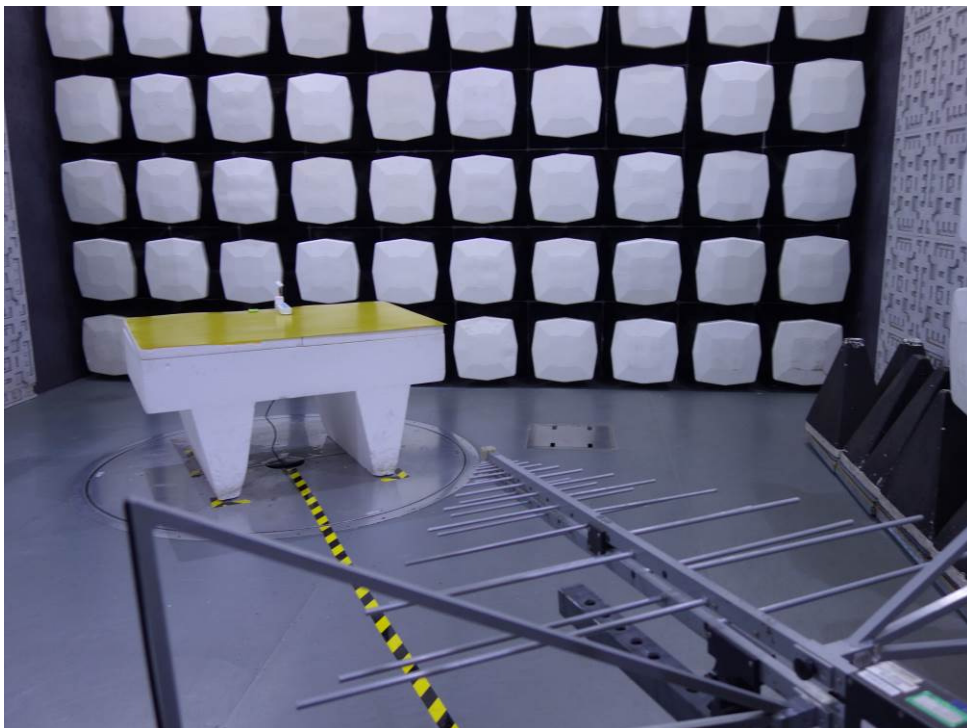
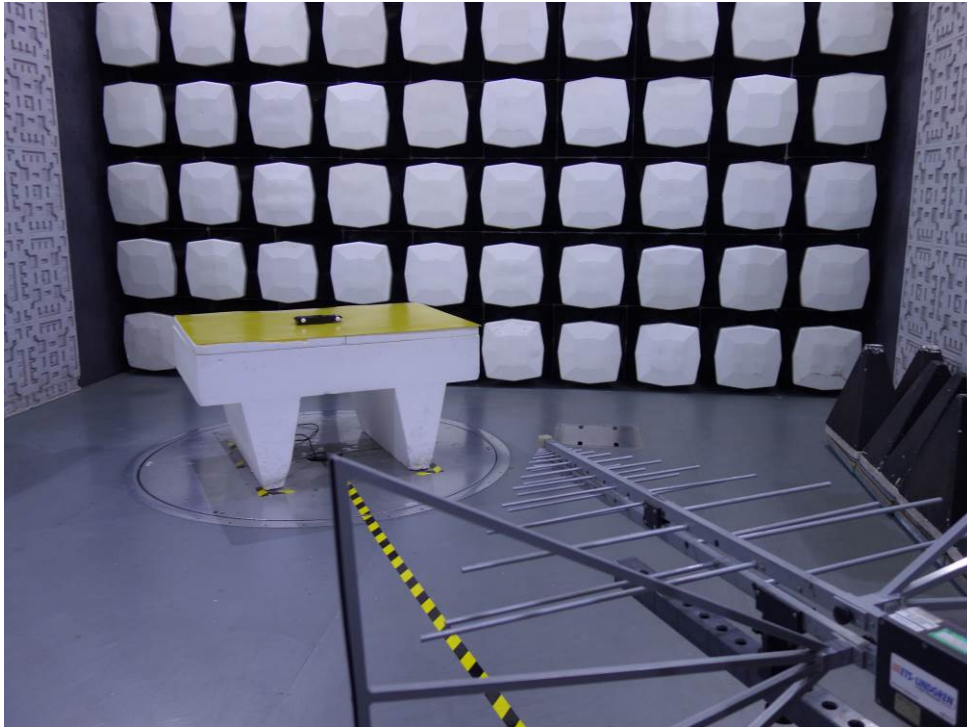

8.3 Voltage Fluctuations and Flicker Test Setup



8.4 Electrostatic Discharge Test Setup



8.5 Electrical Fast Transients/Burst at Power Port Test Setup



8.6 Surge at Power Port Test Setup



8.7 Conducted Immunity at Power Port (150kHz-80MHz) Test Setup

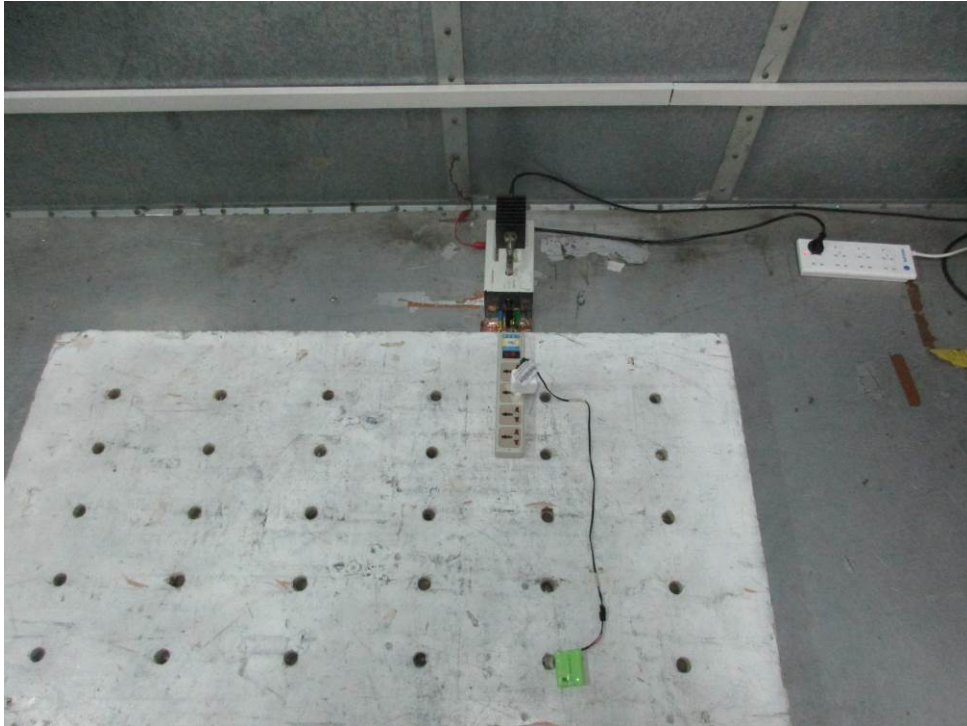

8.8 Voltage Dips and Interruptions Test Setup



8.9 Radiated Immunity (80MHz-6GHz) Test Setup

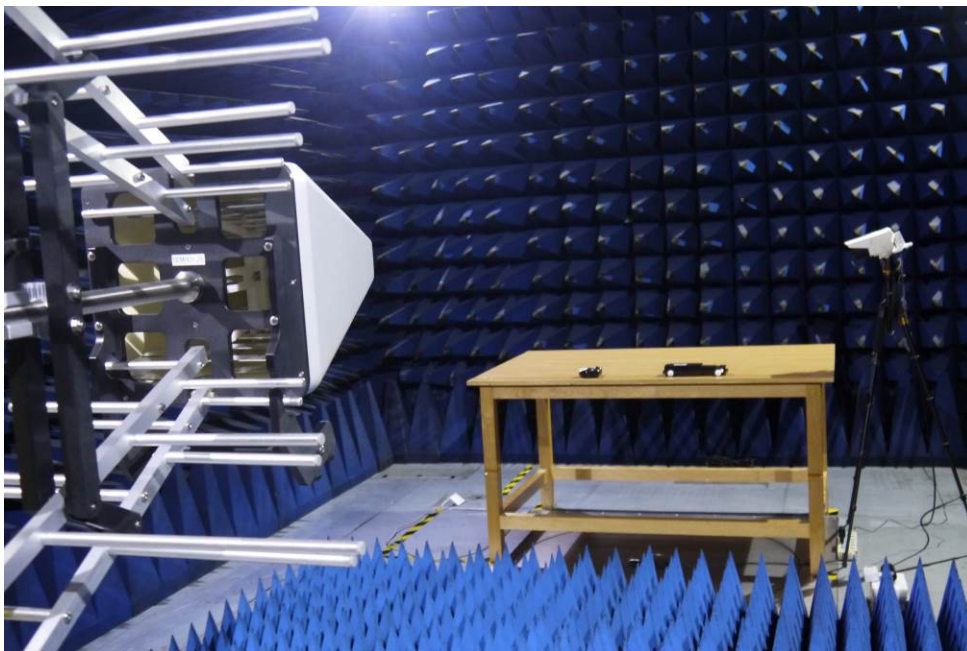
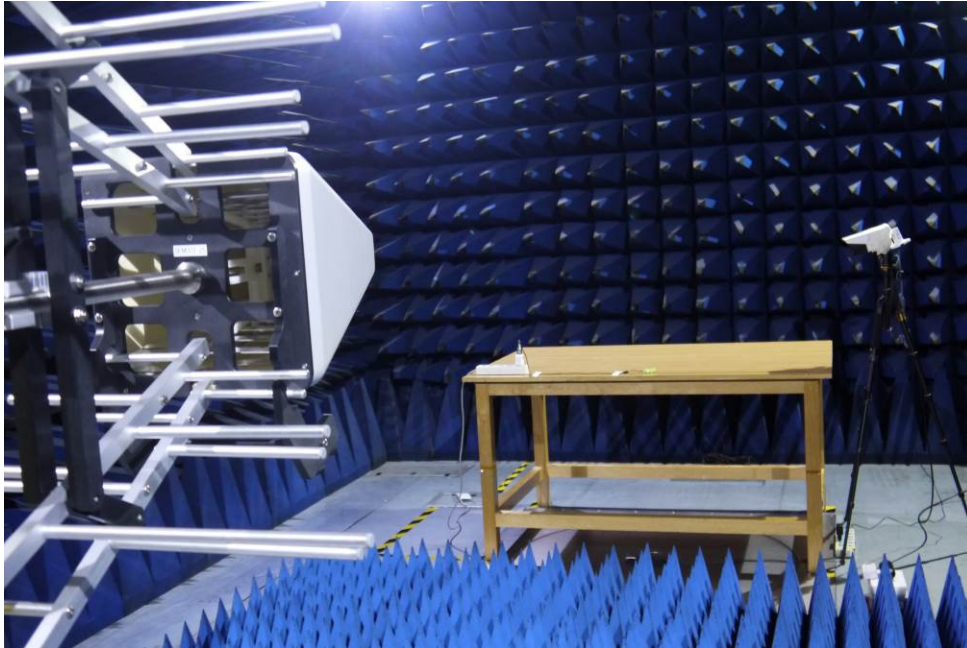

8.10 EUT Constructional Details (EUT Photos)

Refer to Appendix A - Photographs of EUT Constructional Details for SZEM1804003461CR.

- End of the Report -