



**SGS-CSTC Standards Technical Services Co., Ltd.  
Shenzhen Branch**

No. 1 Workshop, M-10, Middle section, Science & Technology Park,  
Shenzhen, Guangdong, China 518057

Telephone: +86 (0) 755 2601 2053  
Fax: +86 (0) 755 2671 0594  
Email: ee.shenzhen@sgs.com

Report No.: SZEM180400346102  
Page: 1 of 36

## TEST REPORT

**Application No.:** SZEM1804003461CR (SGS SZ No.: T51810220173EM)  
**Applicant:** DOBLEEAGLE INDUSTRY (CHINA) LIMITED  
**Address of Applicant:** Xingda Industrial Park, Chenghai District, Shantou City, Guangdong Province, China  
**Manufacturer/ Supplier:** DOBLEEAGLE INDUSTRY (CHINA) LIMITED  
**Equipment Under Test (EUT):**  
**EUT Name:** Building Blocks  
**Item No.:** Please refer to section 2 ♣  
♣ Please refer to section 2 of this report which indicates which item was actually tested and which were electrically identical.  
**Country of Origin:** China  
**Request Age Grading:** 3+  
**Standard(s) :** EN 300 440 V2.1.1  
**Date of Receipt:** 2018-05-04  
**Date of Test:** 2018-05-07 to 2018-05-10  
**Date of Issue:** 2018-05-10

<b>Test Result:</b>	<b>Pass*</b>
---------------------	--------------

\* In the configuration tested, the EUT complied with the standards specified above.

The CE mark as shown below can be used, under the responsibility of the manufacturer, after completion of an EU Declaration of Conformity and compliance with all relevant EU Directives.



Keny Xu  
EMC Laboratory Manager





The manufacturer should ensure that all products in series production are in conformity with the product sample detailed in this report. If the product in this report is used in any configuration other than that detailed in the report, the manufacturer must ensure the new system complies with all relevant standards. Any mention of SGS International Electrical Approvals or testing done by SGS International Electrical Approvals in connection with, distribution or use of the product described in this report must be approved by SGS International Electrical Approvals in writing.

This document is issued by the Company subject to its General Conditions of Service printed overleaf, available on request or accessible at <http://www.sgs.com/en/Terms-and-Conditions.aspx> and, for electronic format documents, subject to Terms and Conditions for Electronic Documents at <http://www.sgs.com/en/Terms-and-Conditions/Terms-e-Documents.aspx>. Attention is drawn to the limitation of liability, indemnification and jurisdiction issues defined therein. Any holder of this document is advised that information contained hereon reflects the Company's findings at the time of its intervention only and within the limits of Client's instructions, if any. The Company's sole responsibility is to its Client and this document does not exonerate parties to a transaction from exercising all their rights and obligations under the transaction documents. This document cannot be reproduced except in full, without prior written approval of the Company. Any unauthorized alteration, forgery or falsification of the content or appearance of this document is unlawful and offenders may be prosecuted to the fullest extent of the law. Unless otherwise stated the results shown in this test report refer only to the sample(s) tested and such sample(s) are retained for 30 days only.



<i>Revision Record</i>				
<i>Version</i>	<i>Chapter</i>	<i>Date</i>	<i>Modifier</i>	<i>Remark</i>
01		2018-05-10		Original

Authorized for issue by:				
				
		<hr/>		
		Gebin Sun /Project Engineer		
				
		<hr/>		
		Eric Fu /Reviewer		

## 2 Test Summary

Radio Spectrum Technical Requirement				
Item	Standard	Method	Requirement	Result
Duty cycle	EN 300 440 V2.1.1	EN 300 440 V2.1.1 clause 4.2.5.3	EN 300 440 V2.1.1 clause 4.2.5.4	Pass

Radio Spectrum Matter Part				
Item	Standard	Method	Requirement	Result
Equivalent isotropically radiated power	EN 300 440 V2.1.1	EN 300 440 V2.1.1 clause 4.2.2.3	EN 300 440 V2.1.1 clause 4.2.2	Pass
Permitted range of operating frequencies	EN 300 440 V2.1.1	EN 300 440 V2.1.1 clause 4.2.3.3	EN 300 440 V2.1.1 clause 4.2.3	Pass
Unwanted emissions in the spurious domain	EN 300 440 V2.1.1	EN 300 440 V2.1.1 clause 4.2.4.3	EN 300 440 V2.1.1 clause 4.2.4	Pass
Spurious Emission	EN 300 440 V2.1.1	EN 300 440 V2.1.1 clause 4.3.5.3	EN 300 440 V2.1.1 clause 4.3.5	Pass

Remark:

Item No.: C51001W, C51002W, C51003W, C51004W, C51005W, C51006W, C51007W, C51008W, C51009W, C51010W, C51011W, C51012W, C51013W, C51014W, C51015W, C51016W, C51017W, C51018W, C51019W, C51020W, C51021W, C51022W, C51023W, C51024W, C51025W, C51026W, C51029W, C51030W, C51031W, C51032W, C51033W, C51034W, C51035W, C51036W, C51037W, C51038W, C51039W, C51040W, C52001W, C52002W, C52003W, C52004W, C52005W, C52006W, C52007W, C52008W, C52009W, C52010W, C52011W, C52012W, C52013W, C52014W, C52015W, C52016W, C52017W, C52018W, C52019W, C52020W, C53001W, C53002W

Only the item C51004W was tested, since the electrical circuit design, layout, components used, internal wiring and functions were identical for all the above items, only different on decorations, colour and item No..



### 3 Contents

	Page
<b>1 COVER PAGE</b> .....	<b>1</b>
<b>2 TEST SUMMARY</b> .....	<b>3</b>
<b>3 CONTENTS</b> .....	<b>4</b>
<b>4 GENERAL INFORMATION</b> .....	<b>5</b>
4.1 DETAILS OF E.U.T. ....	5
4.2 DESCRIPTION OF SUPPORT UNITS .....	5
4.3 MEASUREMENT UNCERTAINTY .....	5
4.4 TEST LOCATION.....	6
4.5 TEST FACILITY.....	6
4.6 DEVIATION FROM STANDARDS.....	6
4.7 ABNORMALITIES FROM STANDARD CONDITIONS .....	6
<b>5 EQUIPMENT LIST</b> .....	<b>7</b>
<b>6 RADIO SPECTRUM TECHNICAL REQUIREMENT</b> .....	<b>10</b>
6.1 DUTY CYCLE.....	10
6.1.1 <i>Test Requirement:</i> .....	10
6.1.2 <i>Conclusion</i> .....	11
<b>7 RADIO SPECTRUM MATTER TEST RESULTS</b> .....	<b>12</b>
7.1 EQUIVALENT ISOTROPICALLY RADIATED POWER.....	12
7.1.1 <i>E.U.T. Operation</i> .....	13
7.1.2 <i>Test Setup Diagram</i> .....	13
7.1.3 <i>Measurement Procedure and Data</i> .....	14
7.2 PERMITTED RANGE OF OPERATING FREQUENCIES.....	15
7.2.1 <i>E.U.T. Operation</i> .....	16
7.2.2 <i>Test Setup Diagram</i> .....	16
7.2.3 <i>Measurement Procedure and Data</i> .....	16
7.3 UNWANTED EMISSIONS IN THE SPURIOUS DOMAIN.....	17
7.3.1 <i>E.U.T. Operation</i> .....	17
7.3.2 <i>Test Setup Diagram</i> .....	17
7.3.3 <i>Measurement Procedure and Data</i> .....	18
7.4 SPURIOUS EMISSION .....	25
7.4.1 <i>E.U.T. Operation</i> .....	25
7.4.2 <i>Test Setup Diagram</i> .....	25
7.4.3 <i>Measurement Procedure and Data</i> .....	26
<b>8 PHOTOGRAPHS</b> .....	<b>33</b>
8.1 EQUIVALENT ISOTROPICALLY RADIATED POWER TEST SETUP .....	33
8.2 UNWANTED EMISSIONS IN THE SPURIOUS DOMAIN TEST SETUP .....	33
8.3 SPURIOUS EMISSION TEST SETUP.....	34
8.4 EUT CONSTRUCTIONAL DETAILS (EUT PHOTOS).....	34
<b>9 APPENDIX</b> .....	<b>35</b>
9.1 APPENDIX 300440 .....	35-36

## 4 General Information

### 4.1 Details of E.U.T.

Power supply:	3.0V DC(1.5V x 2 "AA" Size Batteries) for TX Rechargeable battery DC3.6V for RX
Cable:	USB Cable:60cm unshielded
Operating Frequency:	2.4GHz(2405MHz-2475MHz)
Channel number:	71
Modulation Type:	GFSK
Sample Type:	Portable production
Antenna Type:	Integral
Antenna Gain:	0dBi

### 4.2 Description of Support Units

The EUT has been tested as an independent unit.

### 4.3 Measurement Uncertainty

No.	Item	Measurement Uncertainty
1	Radio Frequency	$7.25 \times 10^{-8}$
2	Duty cycle	0.37%
3	Occupied Bandwidth	3%
4	RF conducted power	0.75dB
5	RF power density	2.84dB
6	Conducted Spurious emissions	0.75dB
7	RF Radiated power	4.5dB (below 1GHz)
		4.8dB (above 1GHz)
8	Radiated Spurious emission test	4.5dB (Below 1GHz)
		4.8dB (Above 1GHz)
9	Temperature test	1 °C
10	Humidity test	3%
11	Supply voltages	1.5%
12	Time	3%



#### **4.4 Test Location**

All tests were performed at:

SGS-CSTC Standards Technical Services Co., Ltd., Shenzhen Branch

No. 1 Workshop, M-10, Middle Section, Science & Technology Park, Shenzhen, Guangdong, China.  
518057.

Tel: +86 755 2601 2053 Fax: +86 755 2671 0594

No tests were sub-contracted.

#### **4.5 Test Facility**

The test facility is recognized, certified, or accredited by the following organizations:

- **CNAS (No. CNAS L2929)**

CNAS has accredited SGS-CSTC Standards Technical Services Co., Ltd. Shenzhen Branch EMC Lab to ISO/IEC 17025:2005 General Requirements for the Competence of Testing and Calibration Laboratories (CNAS-CL01 Accreditation Criteria for the Competence of Testing and Calibration Laboratories) for the competence in the field of testing.

- **A2LA (Certificate No. 3816.01)**

SGS-CSTC Standards Technical Services Co., Ltd., Shenzhen EMC Laboratory is accredited by the American Association for Laboratory Accreditation(A2LA). Certificate No. 3816.01.

- **VCCI**

The 3m Fully-anechoic chamber for above 1GHz, 10m Semi-anechoic chamber for below 1GHz, Shielded Room for Mains Port Conducted Interference Measurement and Telecommunication Port Conducted Interference Measurement of SGS-CSTC Standards Technical Services Co., Ltd. have been registered in accordance with the Regulations for Voluntary Control Measures with Registration No.: G-20026, R-14188, C-12383 and T-11153 respectively.

- **FCC –Designation Number: CN1178**

SGS-CSTC Standards Technical Services Co., Ltd., Shenzhen EMC Laboratory has been recognized as an accredited testing laboratory.

Designation Number: CN1178. Test Firm Registration Number: 406779.

- **Industry Canada (IC)**

Two 3m Semi-anechoic chambers and the 10m Semi-anechoic chamber of SGS-CSTC Standards Technical Services Co., Ltd. Shenzhen Branch EMC Lab have been registered by Certification and Engineering Bureau of Industry Canada for radio equipment testing with Registration No.: 4620C-1, 4620C-2, 4620C-3.

#### **4.6 Deviation from Standards**

None

#### **4.7 Abnormalities from Standard Conditions**

None



## 5 Equipment List

Duty cycle					
Equipment	Manufacturer	Model No	Inventory No	Cal Date	Cal Due Date
Coaxial Cable	SGS	N/A	SEM031-01	2017-07-13	2018-07-12
Attenuator	Weinschel Associates	WA41	SEM021-09	N/A	N/A
DC Power Supply	ZhaoXin	RXN-305D	SEM011-02	2017-09-27	2018-09-26
Spectrum Analyzer	Rohde & Schwarz	FSP	SEM004-06	2017-09-27	2018-09-26
Signal Generator	KEYSIGHT	N5173B	SEM006-05	2017-09-27	2018-09-26
Power Meter	Rohde & Schwarz	NRVS	SEM014-02	2017-09-27	2018-09-26

Equivalent isotropically radiated power					
Equipment	Manufacturer	Model No	Inventory No	Cal Date	Cal Due Date
Coaxial Cable	SGS	N/A	SEM031-01	2017-07-13	2018-07-12
Attenuator	Weinschel Associates	WA41	SEM021-09	N/A	N/A
DC Power Supply	ZhaoXin	RXN-305D	SEM011-02	2017-09-27	2018-09-26
Spectrum Analyzer	Rohde & Schwarz	FSP	SEM004-06	2017-09-27	2018-09-26
Signal Generator	KEYSIGHT	N5173B	SEM006-05	2017-09-27	2018-09-26
Power Meter	Rohde & Schwarz	NRVS	SEM014-02	2017-09-27	2018-09-26

Permitted range of operating frequencies					
Equipment	Manufacturer	Model No	Inventory No	Cal Date	Cal Due Date
Coaxial Cable	SGS	N/A	SEM031-01	2017-07-13	2018-07-12
Attenuator	Weinschel Associates	WA41	SEM021-09	N/A	N/A
DC Power Supply	ZhaoXin	RXN-305D	SEM011-02	2017-09-27	2018-09-26
Spectrum Analyzer	Rohde & Schwarz	FSP	SEM004-06	2017-09-27	2018-09-26
Signal Generator	KEYSIGHT	N5173B	SEM006-05	2017-09-27	2018-09-26
Power Meter	Rohde & Schwarz	NRVS	SEM014-02	2017-09-27	2018-09-26

Unwanted emissions in the spurious domain					
Equipment	Manufacturer	Model No	Inventory No	Cal Date	Cal Due Date
3m Semi-Anechoic Chamber	AUDIX	N/A	SEM001-02	2018-03-13	2021-03-12
Measurement Software	AUDIX	e3 V8.2014-6-27	N/A	N/A	N/A
Coaxial Cable	SGS	N/A	SEM026-01	2017-07-13	2018-07-12
Spectrum Analyzer	Rohde & Schwarz	FSU43	SEM004-08	2018-04-02	2019-04-01
BiConiLog Antenna (26-3000MHz)	ETS-Lindgren	3142C	SEM003-01	2017-06-27	2020-06-26
Horn Antenna (1-18GHz)	Rohde & Schwarz	HF907	SEM003-07	2018-04-13	2021-04-12
Horn Antenna(15GHz-40GHz)	Schwarzbeck	BBHA 9170	SEM003-15	2017-10-17	2020-10-16



**SGS-CSTC Standards Technical Services Co., Ltd.  
Shenzhen Branch**

Report No.: SZEM180400346102

Page: 8 of 36

Pre-amplifier (0.1-1300MHz)	HP	8447D	SEM005-02	2017-09-27	2018-09-26
Low Noise Amplifier(100MHz-18GHz)	Black Diamond Series	BDLNA-0118-352810	SEM005-05	2017-09-27	2018-09-27
Pre-amplifier(18-26GHz)	Rohde & Schwarz	CH14-H052	SEM005-17	2018-04-02	2019-04-01
Pre-amplifier(26GHz-40GHz)	Compliance Directions Systems Inc.	PAP-2640-50	SEM005-08	2018-04-02	2019-04-01
DC Power Supply	Zhao Xin	RXN-305D	SEM011-02	2017-09-27	2018-09-26
Active Loop Antenna	ETS-Lindgren	6502	SEM003-08	2017-08-22	2020-08-21
Band filter	N/A	N/A	SEM023-01	N/A	N/A

<b>Spurious Emission</b>					
<b>Equipment</b>	<b>Manufacturer</b>	<b>Model No</b>	<b>Inventory No</b>	<b>Cal Date</b>	<b>Cal Due Date</b>
3m Semi-Anechoic Chamber	AUDIX	N/A	SEM001-02	2018-03-13	2021-03-12
Measurement Software	AUDIX	e3 V8.2014-6-27	N/A	N/A	N/A
Coaxial Cable	SGS	N/A	SEM026-01	2017-07-13	2018-07-12
Spectrum Analyzer	Rohde & Schwarz	FSU43	SEM004-08	2018-04-02	2019-04-01
BiConiLog Antenna (26-3000MHz)	ETS-Lindgren	3142C	SEM003-01	2017-06-27	2020-06-26
Horn Antenna (1-18GHz)	Rohde & Schwarz	HF907	SEM003-07	2018-04-13	2021-04-12
Horn Antenna(15GHz-40GHz)	Schwarzbeck	BBHA 9170	SEM003-15	2017-10-17	2020-10-16
Pre-amplifier (0.1-1300MHz)	HP	8447D	SEM005-02	2017-09-27	2018-09-26
Low Noise Amplifier(100MHz-18GHz)	Black Diamond Series	BDLNA-0118-352810	SEM005-05	2017-09-27	2018-09-27
Pre-amplifier(18-26GHz)	Rohde & Schwarz	CH14-H052	SEM005-17	2018-04-02	2019-04-01
Pre-amplifier(26GHz-40GHz)	Compliance Directions Systems Inc.	PAP-2640-50	SEM005-08	2018-04-02	2019-04-01
DC Power Supply	Zhao Xin	RXN-305D	SEM011-02	2017-09-27	2018-09-26
Active Loop Antenna	ETS-Lindgren	6502	SEM003-08	2017-08-22	2020-08-21
Band filter	N/A	N/A	SEM023-01	N/A	N/A





**SGS-CSTC Standards Technical Services Co., Ltd.  
Shenzhen Branch**

Report No.: SZEM180400346102

Page: 9 of 36

<b>General used equipment</b>					
<b>Equipment</b>	<b>Manufacturer</b>	<b>Model No</b>	<b>Inventory No</b>	<b>Cal Date</b>	<b>Cal Due Date</b>
Humidity/ Temperature Indicator	Shanghai Meteorological Industry Factory	ZJ1-2B	SEM002-03	2017-09-29	2018-09-28
Humidity/ Temperature Indicator	Shanghai Meteorological Industry Factory	ZJ1-2B	SEM002-04	2017-09-29	2018-09-28
Humidity/ Temperature Indicator	Mingle	N/A	SEM002-08	2017-09-29	2018-09-28
Barometer	Changchun Meteorological Industry Factory	DYM3	SEM002-01	2018-04-08	2019-04-07

## 6 Radio Spectrum Technical Requirement

### 6.1 Duty cycle

#### 6.1.1 Test Requirement:

EN 300 440 V2.1.1 clause 4.2.5.4

Limit:

**Table 6: Duty cycle limits**

Frequency	Duty cycle	Application	Notes
2 400 MHz to 2 483,5 MHz	No Restriction	Generic use	
2 400 MHz to 2 483,5 MHz	No Restriction	Detection, movement and alert applications	
(a) 2 446 MHz to 2 454 MHz	No Restriction	RFID	See annex C
(b) 2 446 MHz to 2 454 MHz	4 W e.i.r.p.	RFID	See annex C
5 725 MHz to 5 875 MHz	No Restriction	Generic use	
9 200 MHz to 9 500 MHz	No Restriction	Radiodetermination: radar, detection, movement and alert applications	
9 500 MHz to 9 975 MHz	No Restriction	Radiodetermination: Radar, detection, movement and alert applications	
10,5 GHz to 10,6 GHz	No Restriction	Radiodetermination: Radar, detection, movement and alert applications	
13,4 GHz to 14,0 GHz	No Restriction	Radiodetermination: Radar, detection, movement and alert applications	
17,1 GHz to 17,3 GHz	DAA or Equivalent techniques	Radiodetermination: GBSAR detection, movement and alert applications	See annex E
24,00 GHz to 24,25 GHz	No Restriction	Generic use and Radiodetermination: radar, detection, movement and alert applications	



### 6.1.2 Conclusion

Standard Requirement:

For automatic operated devices, either software controlled or pre-programmed devices, the provider shall declare the duty cycle for the equipment under test, see table 6.

For manual operated or event dependant devices, with or without software controlled functions, the provider shall declare whether the device once triggered, follows a pre-programmed cycle, or whether the transmitter remains on until the trigger is released or the device is manually reset. The provider shall also give a description of the application for the device and include a typical usage pattern. The typical usage pattern as declared by the provider shall be used to determine the duty cycle and compare to the limit in table 6. Where an acknowledgement is required, the additional transmitter on-time shall be included and declared by the provider.

For devices with a 100 % duty cycle transmitting an unmodulated carrier most of the time, a time-out shut-off facility shall be implemented in order to improve the efficient use of spectrum. The method of implementation shall be declared by the provider.

Duty cycle is the ratio expressed as a percentage, of the cumulative duration of transmissions  $T_{on\_cum}$  within an observation interval  $T_{obs}$  on an observation bandwidth  $F_{obs}$ .

$T_{obs}$  is 1 hour, also equal to 3600s.

$T_{on\_cum}$  is 2790s as declared by manufacturer within an observation interval  $T_{obs}$ .

Duty Cycle=  $T_{on\_cum} / T_{obs} = 2790s / 3600s = 77.5\%$ , which is less than 100%.

## 7 Radio Spectrum Matter Test Results

### 7.1 Equivalent isotropically radiated power

Test Requirement EN 300 440 V2.1.1 clause 4.2.2  
Test Method: EN 300 440 V2.1.1 clause  
4.2.2.3  
Limit:

**Table 4: Maximum radiated peak power (e.i.r.p.)**

Frequency	Power	Application	Notes
2 400 MHz to 2 483,5 MHz	10 mW e.i.r.p.	Generic use	
2 400 MHz to 2 483,5 MHz	25 mW e.i.r.p.	Detection, movement and alert applications	
(a) 2 446 MHz to 2 454 MHz	500 mW e.i.r.p.	RFID	See also table 6 and annex C
(b) 2 446 MHz to 2 454 MHz	4 W e.i.r.p.	RFID	See also table 6 and annex C
5 725 MHz to 5 875 MHz	25 mW e.i.r.p.	Generic use	
9 200 MHz to 9 500 MHz	25 mW e.i.r.p.	Radiodetermination: radar, detection, movement and alert applications	
9 500 MHz to 9 975 MHz	25 mW e.i.r.p.	Radiodetermination: Radar, detection, movement and alert applications	
10,5 GHz to 10,6 GHz	500 mW e.i.r.p.	Radiodetermination: Radar, detection, movement and alert applications	
13,4 GHz to 14,0 GHz	25 mW e.i.r.p.	Radiodetermination: Radar, detection, movement and alert applications	
17,1 GHz to 17,3 GHz	400 mW e.i.r.p.	Radiodetermination: GBSAR detection, movement and alert applications	See annex E
24,00 GHz to 24,25 GHz	100 mW e.i.r.p.	Generic use and Radiodetermination: radar, detection, movement and alert applications	

**7.1.1 E.U.T. Operation**

Operating Environment:

Temperature: 23 °C Humidity: 53.3 % RH Atmospheric Pressure: 1020 mbar

Test mode d:TX mode\_Keep the EUT in transmitting mode.

**7.1.2 Test Setup Diagram**

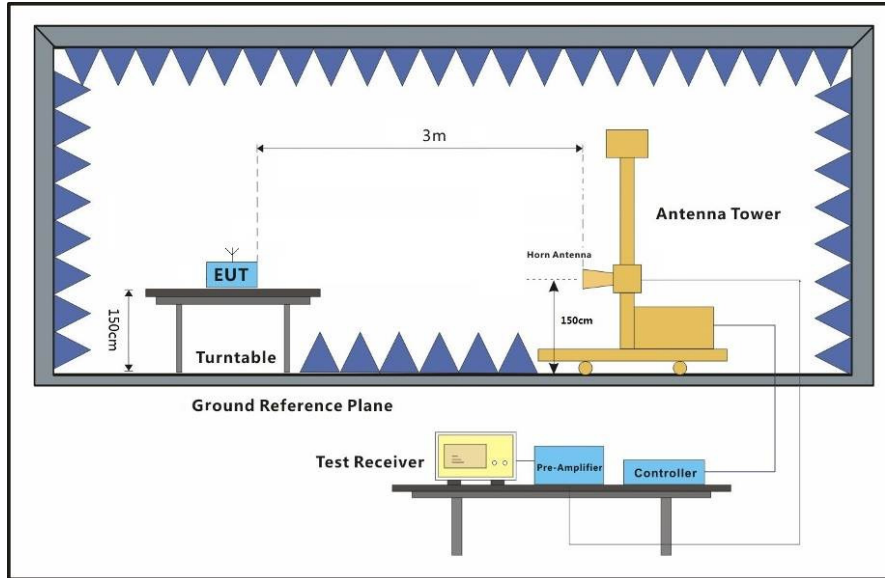

### 7.1.3 Measurement Procedure and Data

1. Using test software to set up the lowest channel, the middle channel, the highest channel.
2. The technique used to find the radiated power of the transmitter was the antenna substitution method. Substitution method was performed to determine the actual EIRP emission levels of the EUT.

The following test procedure as below:

- 1) The EUT was powered ON and placed on a table in the chamber. The antenna of the transmitter was extended to its maximum length.
- 2) The disturbance of the transmitter was maximized on the test receiver display by raising and lowering the receive antenna and by rotating through 360° the turntable. After the fundamental emission was maximized, a field strength measurement was made.
- 3) Steps 1) and 2) were performed with the EUT and the receive antenna in both vertical and horizontal polarization.
- 4) The transmitter was then removed and replaced with substitution antenna. The center of the antenna was approximately at the same location as the center of the transmitter.
- 5) A signal at the disturbance was fed to the substitution antenna by means of a non-radiating cable. With both the substitution and the receive antennas horizontally polarized, the receive antenna was raised and lowered to obtain a maximum reading at the test receiver. The level of the signal generator was adjusted until the measured field strength level in step 2) is obtained for this set of conditions.
- 6) The output power into the substitution antenna was then measured.
- 7) Steps 5) and 6) were repeated with both antennas polarized.
- 8) Pretest the EUT at different transmission time slot data and worst case data in the report.
- 9) Calculate power in dBm by the following formula:

$EIRP \text{ valuse (dBm)} = P_g(\text{dBm}) - \text{cable loss (dB)} + \text{antenna gain (dBi)}$

where:

$P_g$  is the generator output power into the substitution antenna.

The detailed test data see: Appendix 300440



## **7.2 Permitted range of operating frequencies**

Test Requirement EN 300 440 V2.1.1 clause 4.2.3

Test Method: EN 300 440 V2.1.1 clause  
4.2.3.3

Limit:

The width of the power spectrum envelope is  $f_H - f_L$  for a given operating frequency. In equipment that allows adjustment or selection of different operating frequencies, the power envelope takes up different positions in the

allowed band. The frequency range is determined by the lowest value of  $f_L$  and the highest value of  $f_H$  resulting from the adjustment of the equipment to the lowest and highest operating frequencies.

The occupied bandwidth (i.e. the bandwidth in which 99 % of the wanted emission is contained) and the necessary bandwidth of the transmitter shall fall within the assigned frequency band.

For all equipment the frequency range shall lie within the frequency band given by clause 7.1.3, table 4. For non-harmonized frequency bands the available frequency range may differ between national administrations.

**7.2.1 E.U.T. Operation**

Operating Environment:

Temperature: 23 °C Humidity: 53.2 % RH Atmospheric Pressure: 1020 mbar

Test mode d:TX mode\_Keep the EUT in transmitting mode.

**7.2.2 Test Setup Diagram**

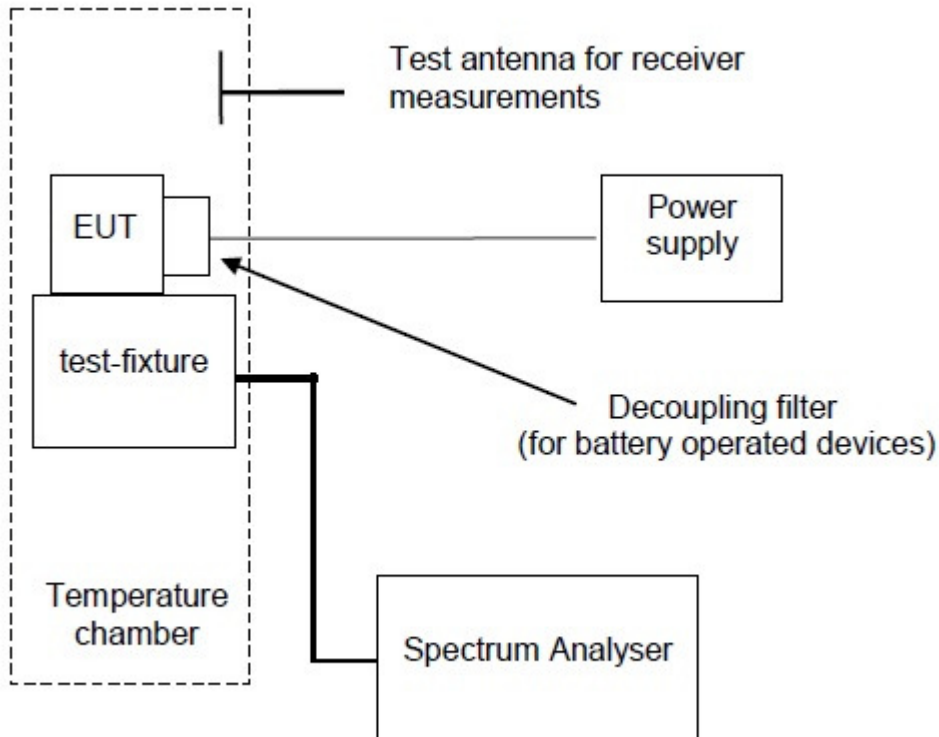

**7.2.3 Measurement Procedure and Data**

The detailed test data see: Appendix 300440



### 7.3 Unwanted emissions in the spurious domain

Test Requirement EN 300 440 V2.1.1 clause 4.2.4  
 Test Method: EN 300 440 V2.1.1 clause 4.2.4.3  
 Measurement Distance: 3m  
 Test setting: RBW: 1 MHz  
 VBW: 3 MHz  
 Detector Mode: RMS  
 Limit:

**Table 5: Spurious emissions**

Frequency ranges	47 MHz to 74 MHz 87,5 MHz to 108 MHz 174 MHz to 230 MHz 470 MHz to 862 MHz	Other frequencies ≤1 000 MHz	Frequencies >1 000 MHz
Operating	4nW (-54dBm)	250nW (-36dBm)	1uW (-30dBm)
Standby	2nW (-57dBm)	2nW (-57dBm)	20nW (-47dBm)

#### 7.3.1 E.U.T. Operation

Operating Environment:  
 Temperature: 24.8 °C Humidity: 56 % RH Atmospheric Pressure: 1020 mbar  
 Test mode d:TX mode\_Keep the EUT in transmitting mode.  
 f:Standby mode,keep EUT standby.

#### 7.3.2 Test Setup Diagram

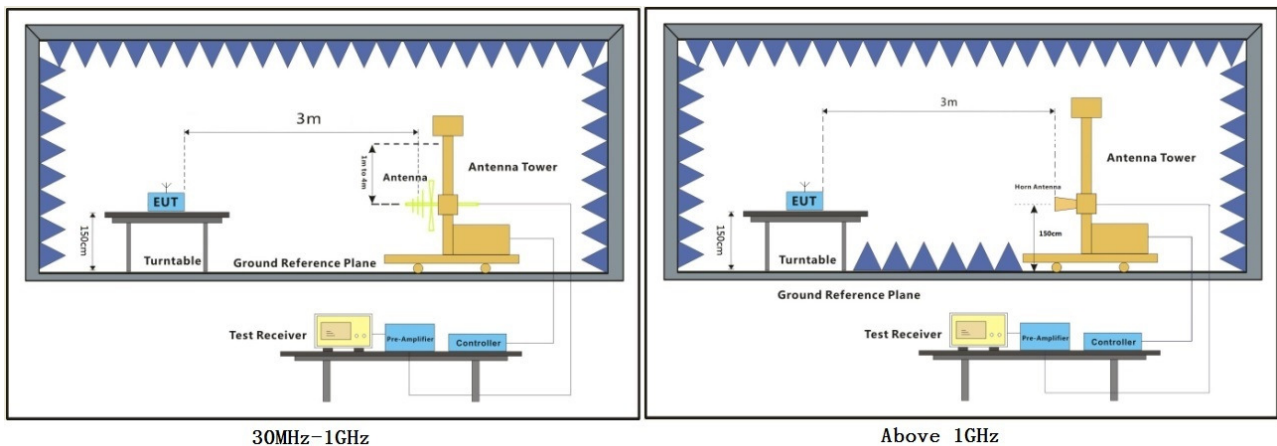

### 7.3.3 Measurement Procedure and Data

1. Using test software to set up the lowest channel, the middle channel and the highest channel.
2. Scan from 25MHz to 25GHz, find the maximum radiation frequency to measure. No Standby Mode apply for the EUT.
3. The technique used to find the Spurious Emissions of the transmitter was the antenna substitution method. Substitution method was performed to determine the actual ERP/EIRP emission levels of the EUT.

Below 1GHz test procedure as below:

- 1) The EUT was powered ON and placed on a table in the chamber. The antenna of the transmitter was extended to its maximum length. If possible, without modulation and the measuring receiver shall be tuned to the frequency of the transmitter under test.
- 2) The disturbance of the transmitter was maximized on the test receiver display by raising and lowering the receive antenna and by rotating through 360° the turntable. After the fundamental emission was maximized, a field strength measurement was made.
- 3) Steps 1) and 2) were performed with the EUT and the receive antenna in both vertical and horizontal polarization.
- 4) The transmitter was then removed and replaced with another antenna. The center of the antenna was approximately at the same location as the center of the transmitter.
- 5) A signal at the disturbance was fed to the substitution antenna by means of a non-radiating cable. With both the substitution and the receive antennas horizontally polarized, the receive antenna was raised and lowered to obtain a maximum reading at the test receiver. The level of the signal generator was adjusted until the measured field strength level in step 2) is obtained for this set of conditions.
- 6) The output power into the substitution antenna was then measured.
- 7) Steps 5) and 6) were repeated with both antennas polarized.
- 8) Calculate power in dBm by the following formula:  
$$\text{ERP(dBm)} = \text{Pg(dBm)} - \text{cable loss (dB)} + \text{antenna gain (dBi)}$$

where:

Pg is the generator output power into the substitution antenna.

Above 1GHz test procedure as below:

- 1) Different between above is the test site, change from Semi- Anechoic Chamber to fully Anechoic Chamber.
- 2) Calculate power in dBm by the following formula:  
$$\text{EIRP(dBm)} = \text{Pg(dBm)} - \text{cable loss (dB)} + \text{antenna gain (dBi)}$$

where:

Pg is the generator output power into the substitution antenna.

Standby mode test procedure as below:

- 1) Steps 1) to 8) and 1) to 2) shall be repeated with the transmitter in the standby condition if this option is available.



Mode:d; Polarization:Horizontal; Modulation:GFSK; Highest channel

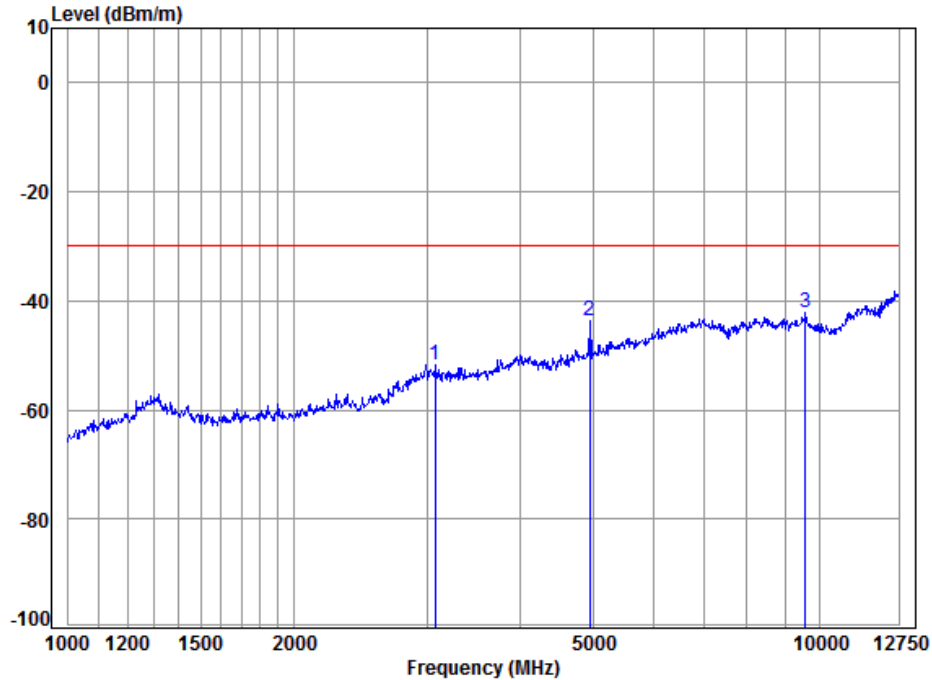

Condition: 3m HORIZONTAL  
Job No.: 03461CR  
Test mode: 2475 TX SE

Marker	Freq. MHz	Level dBm	Limit dBm	Over Limit dB
1	3080.60	-51.62	-30.00	-21.62
2	4946.07	-43.60	-30.00	-13.60
3	9562.85	-42.05	-30.00	-12.05



Mode:d; Polarization:Horizontal ; Modulation:GFSK ;Lowest channel

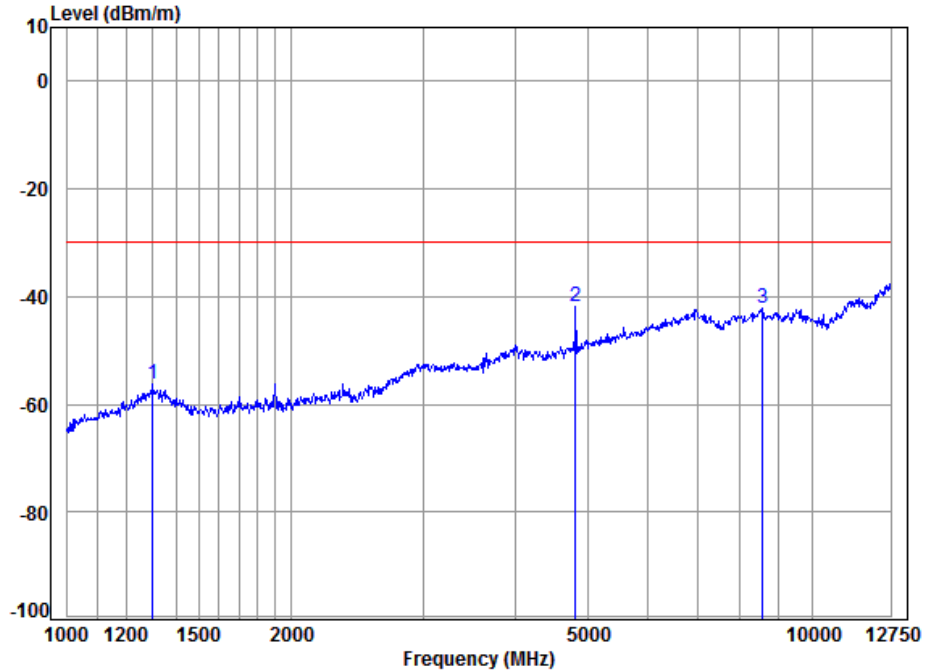

Condition: 3m HORIZONTAL  
Job No.: 03461CR  
Test mode: 2405 TX SE

Marker	Freq. MHz	Level dBm	Limit dBm	Over Limit dB
1	1303.09	-56.30	-30.00	-26.30
2	4809.50	-41.91	-30.00	-11.91
3	8571.38	-42.22	-30.00	-12.22

Mode:d; Polarization:Horizontal ; Modulation:GFSK ;Middle channel

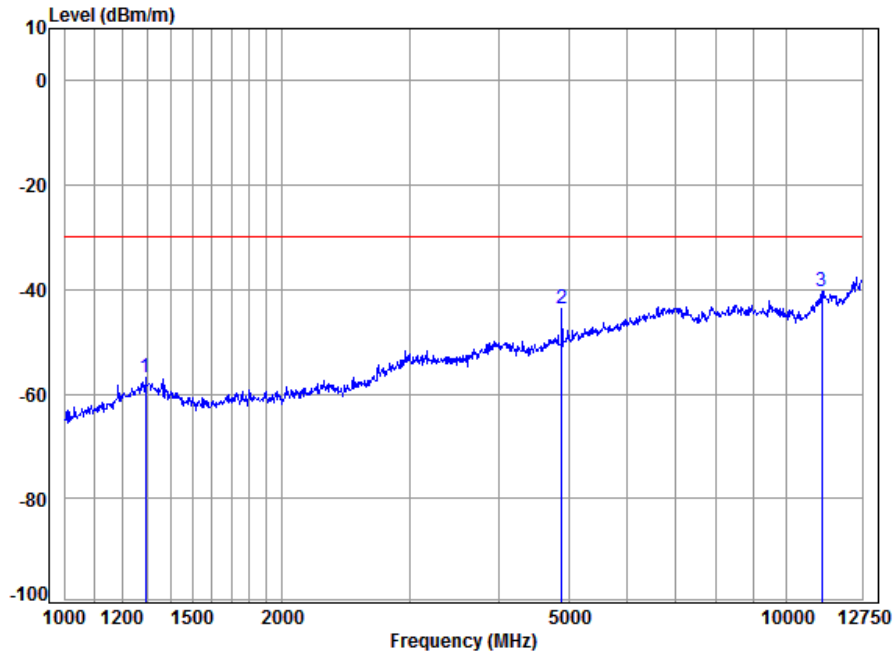

Condition: 3m HORIZONTAL  
 Job No.: 03461CR  
 Test mode: 2440 TX SE

Marker	Freq. MHz	Level dBm	Limit dBm	Over Limit dB
1	1293.17	-56.95	-30.00	-26.95
2	4883.52	-43.62	-30.00	-13.62
3	11197.71	-40.41	-30.00	-10.41



Mode:d; Polarization:Vertical ; Modulation:GFSK ;Highest channel

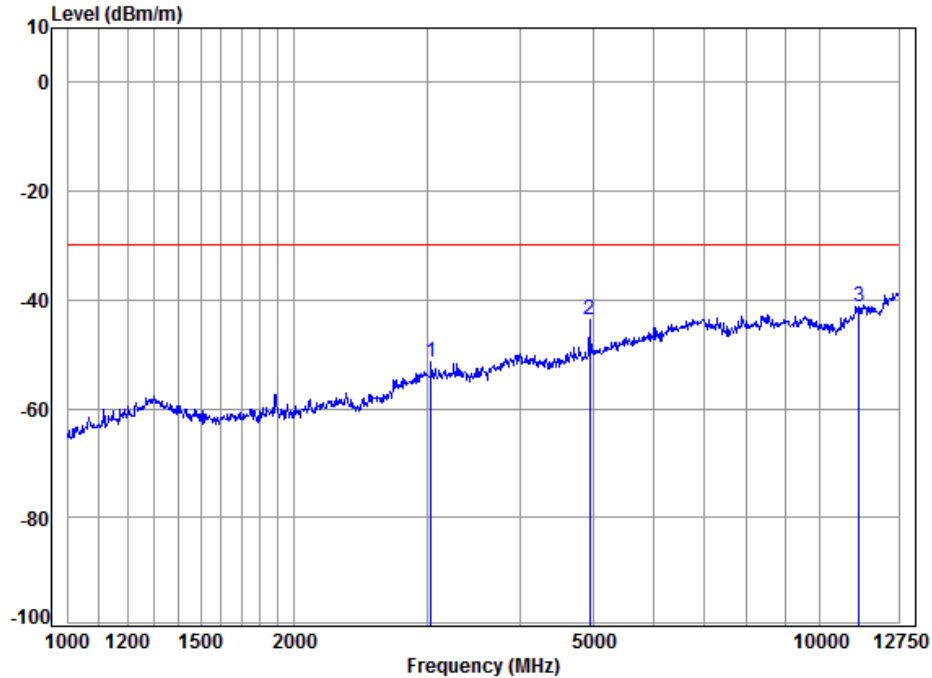

Condition: 3m VERTICAL  
Job No.: 03461CR  
Test mode: 2475 TX SE

Marker	Freq. MHz	Level dBm	Limit dBm	Over Limit dB
1	3041.64	-51.33	-30.00	-21.33
2	4946.07	-43.78	-30.00	-13.78
3	11283.55	-41.35	-30.00	-11.35



Mode:d; Polarization:Vertical ; Modulation:GFSK ;Lowest channel

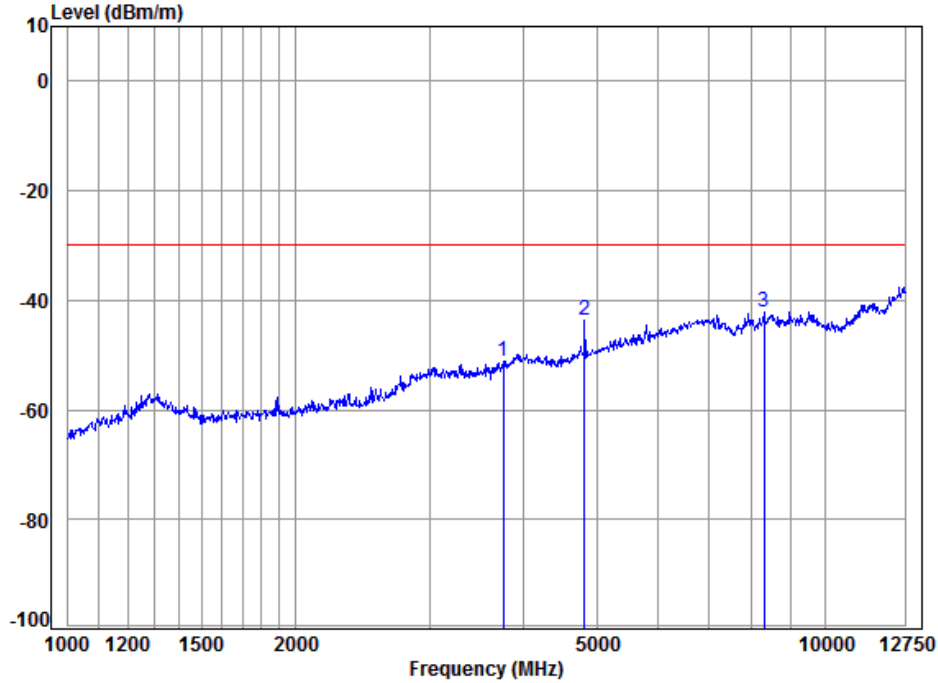

Condition: 3m VERTICAL  
Job No.: 03461CR  
Test mode: 2405 TX SE

Marker	Freq. MHz	Level dBm	Limit dBm	Over Limit dB
1	3757.21	-51.26	-30.00	-21.26
2	4809.50	-43.55	-30.00	-13.55
3	8292.38	-42.14	-30.00	-12.14



Mode:d; Polarization:Vertical ; Modulation:GFSK ;Middle channel

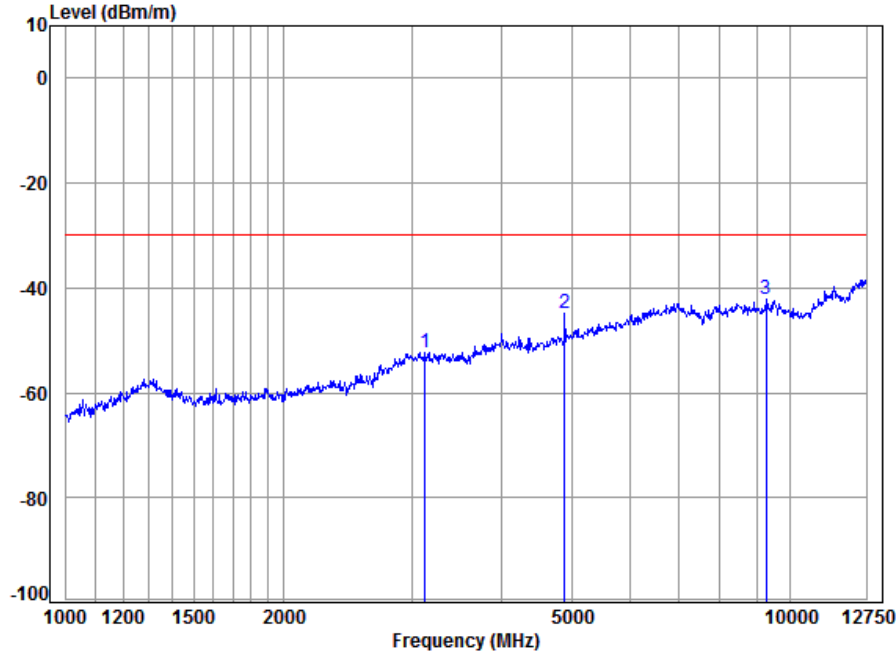

Condition: 3m VERTICAL  
Job No.: 03461CR  
Test mode: 2440 TX SE

Marker	Freq. MHz	Level dBm	Limit dBm	Over Limit dB
1	3135.99	-52.28	-30.00	-22.28
2	4883.52	-44.70	-30.00	-14.70
3	9275.16	-42.30	-30.00	-12.30

**Remark:**

The disturbance above 12GHz and below 1GHz was very low, and the above harmonics were the highest point could be found when testing, so only the above harmonics had been displayed.



### 7.4 Spurious Emission

Test Requirement EN 300 440 V2.1.1 clause 4.3.5  
 Test Method: EN 300 440 V2.1.1 clause 4.3.5.3  
 Measurement Distance: 3m  
 Test setting: RBW: 30 KHz  
 VBW: 100 KHz  
 Detector Mode: Peak  
 Limit:

The spurious emissions of the receiver shall not exceed the values in tables in the indicated bands:

Frequency Range	Limit
25 MHz to 1 GHz	2nW(-57dBm)
Above 1GHz	20nW(-47dBm)

#### 7.4.1 E.U.T. Operation

Operating Environment:  
 Temperature: 24.8 °C Humidity: 56 % RH Atmospheric Pressure: 1020 mbar  
 Test mode e:RX mode\_Keep the EUT in receiving mode.

#### 7.4.2 Test Setup Diagram

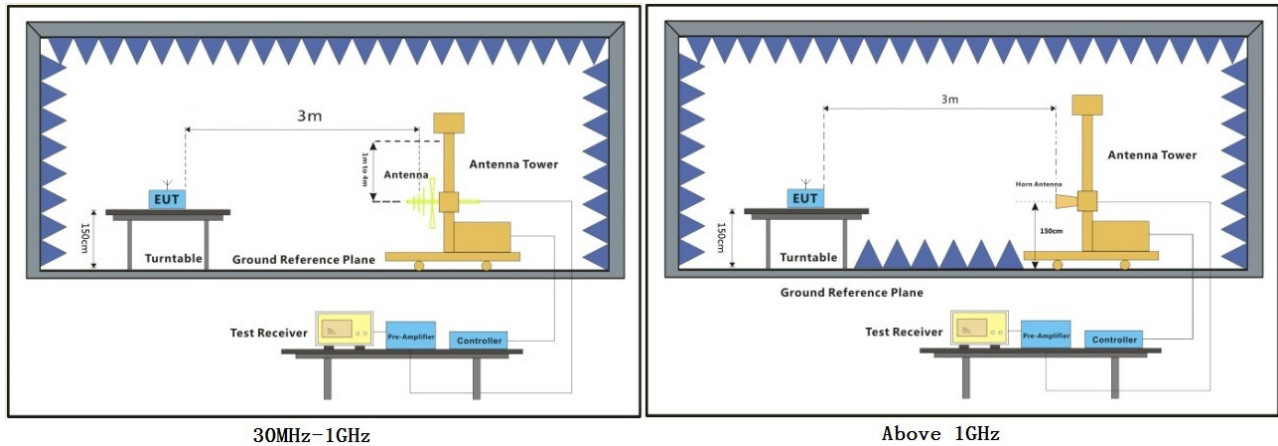

### 7.4.3 Measurement Procedure and Data

1. Using test software to set up the lowest channel, the middle channel and the highest channel.
2. Scan from 25MHz to 25GHz, find the maximum radiation frequency to measure. No Standby Mode apply for the EUT.
3. The technique used to find the Spurious Emissions of the transmitter was the antenna substitution method. Substitution method was performed to determine the actual ERP/EIRP emission levels of the EUT.

Below 1GHz test procedure as below:

- 1) The EUT was powered ON and placed on a table in the chamber. The antenna of the transmitter was extended to its maximum length. Receiver mode and the measuring receiver shall be tuned to the frequency of the transmitter under test.
- 2) The disturbance of the transmitter was maximized on the test receiver display by raising and lowering the receive antenna and by rotating through 360° the turntable. After the fundamental emission was maximized, a field strength measurement was made.
- 3) Steps 1) and 2) were performed with the EUT and the receive antenna in both vertical and horizontal polarization.
- 4) The transmitter was then removed and replaced with another antenna. The center of the antenna was approximately at the same location as the center of the transmitter.
- 5) A signal at the disturbance was fed to the substitution antenna by means of a non-radiating cable. With both the substitution and the receive antennas horizontally polarized, the receive antenna was raised and lowered to obtain a maximum reading at the test receiver. The level of the signal generator was adjusted until the measured field strength level in step 2) is obtained for this set of conditions.
- 6) The output power into the substitution antenna was then measured.
- 7) Steps 5) and 6) were repeated with both antennas polarized.
- 8) Calculate power in dBm by the following formula:  
$$\text{ERP(dBm)} = \text{Pg(dBm)} - \text{cable loss (dB)} + \text{antenna gain (dBi)}$$

where:

Pg is the generator output power into the substitution antenna.

Above 1GHz test procedure as below:

- 1) Different between above is the test site, change from Semi- Anechoic Chamber to fully Anechoic Chamber.
- 2) Calculate power in dBm by the following formula:  
$$\text{EIRP(dBm)} = \text{Pg(dBm)} - \text{cable loss (dB)} + \text{antenna gain (dBi)}$$

where:

Pg is the generator output power into the substitution antenna.



Mode:e; Polarization:Horizontal; Modulation:GFSK; ; Channel:Low

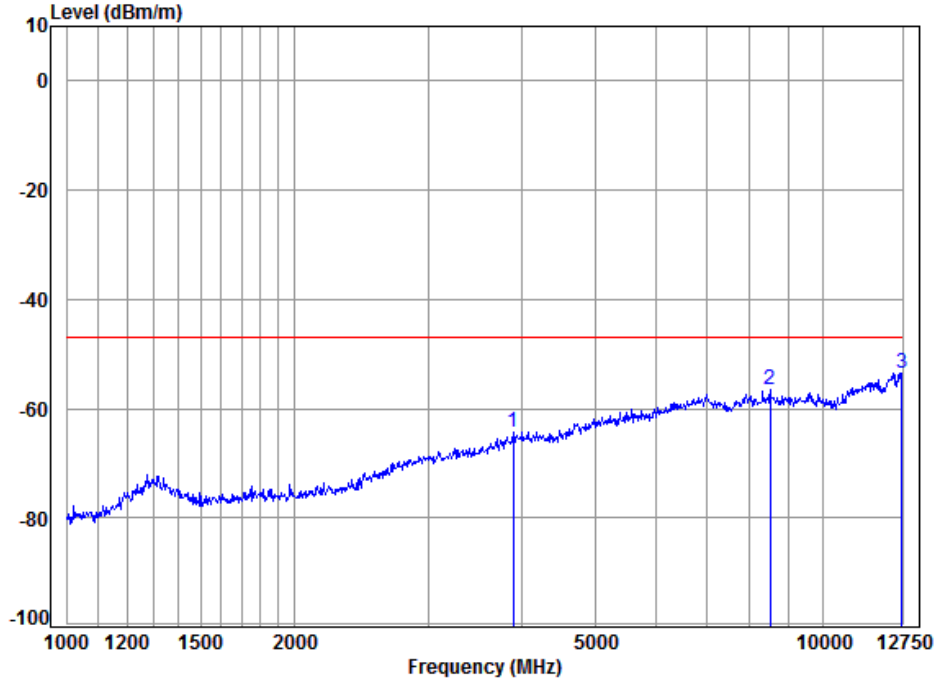

Condition: 3m HORIZONTAL  
Job No.: 03461CR  
Test mode: 2405 RX SE

Marker	Freq. MHz	Level dBm	Limit dBm	Over Limit dB
1	3893.52	-64.23	-47.00	-17.23
2	8506.17	-56.50	-47.00	-9.50
3	12717.59	-53.44	-47.00	-6.44



Mode:e; Polarization:Vertical; Modulation:GFSK; ; Channel:Low

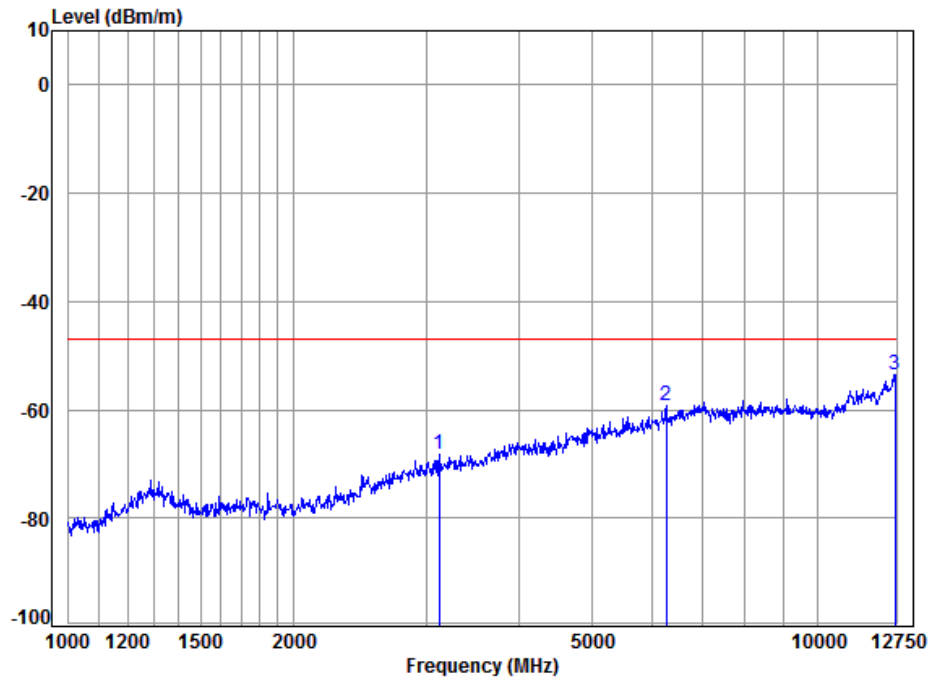

Condition: 3m Vertical  
Job No.: 03461CR  
Test mode: 2405 RX SE

Marker	Freq. MHz	Level dBm	Limit dBm	Over Limit dB
1	3128.01	-68.09	-47.00	-21.09
2	6283.16	-59.10	-47.00	-12.10
3	12685.25	-53.41	-47.00	-6.41



Mode:e; Polarization:Horizontal; Modulation:GFSK; ; Channel:middle

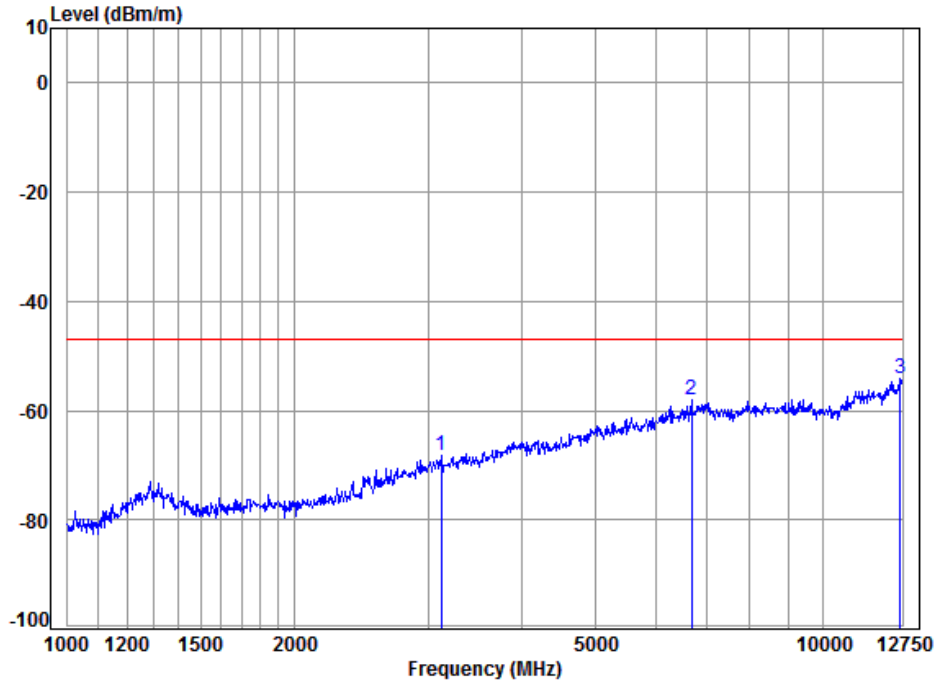

Condition: 3m HORIZONTAL  
Job No.: 03461CR  
Test mode: 2440 RX SE

Marker	Freq. MHz	Level dBm	Limit dBm	Over Limit dB
1	3128.01	-68.09	-47.00	-21.09
2	6696.01	-58.14	-47.00	-11.14
3	12653.00	-54.25	-47.00	-7.25



Mode:e; Polarization:Vertical; Modulation:GFSK; ; Channel:middle

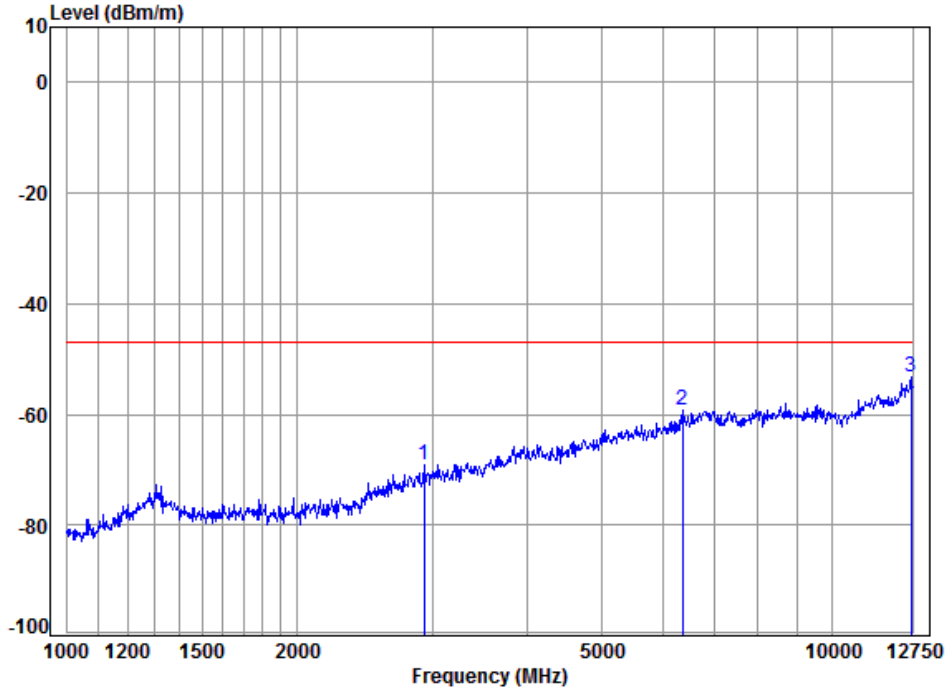

Condition: 3m VERTICAL  
Job No.: 03461CR  
Test mode: 2440 RX SE

Marker	Freq. MHz	Level dBm	Limit dBm	Over Limit dB
1	2927.69	-69.21	-47.00	-22.21
2	6379.86	-59.38	-47.00	-12.38
3	12685.25	-53.37	-47.00	-6.37



Mode:e; Polarization:Horizontal; Modulation:GFSK; ; Channel:High

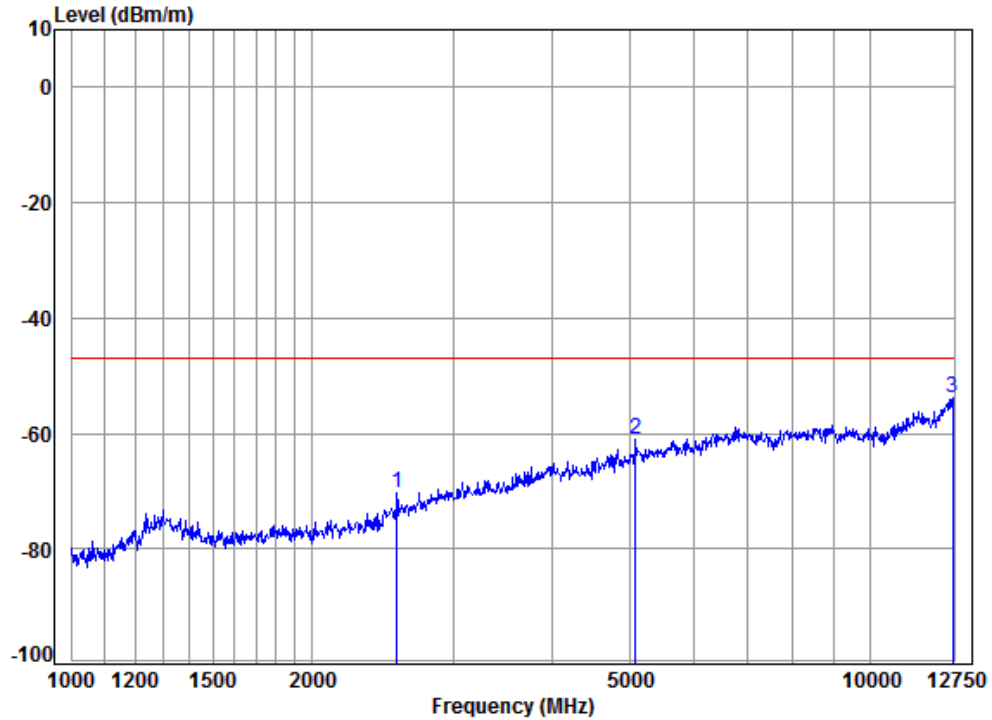

Condition: 3m HORIZONTAL  
Job No.: 03461CR  
Test mode: 2475 RX SE

Marker	Freq. MHz	Level dBm	Limit dBm	Over Limit dB
1	2551.69	-70.39	-47.00	-23.39
2	5086.52	-60.91	-47.00	-13.91
3	12685.25	-53.98	-47.00	-6.98



Mode:e; Polarization:Vertical; Modulation:GFSK; ; Channel:High

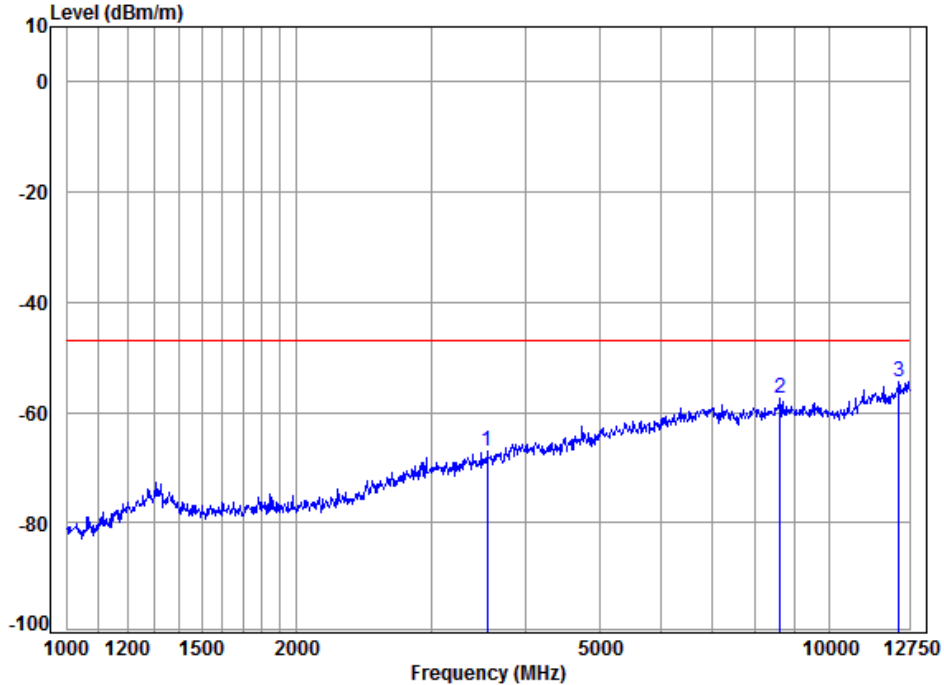

Condition: 3m VERTICAL  
Job No.: 03461CR  
Test mode: 2475 RX SE

Marker	Freq. MHz	Level dBm	Limit dBm	Over Limit dB
1	3561.64	-67.09	-47.00	-20.09
2	8615.13	-57.52	-47.00	-10.52
3	12334.98	-54.50	-47.00	-7.50

**Remark:**

The disturbance above 9GHz and below 2GHz was very low, and the above harmonics were the highest point could be found when testing, so only the above harmonics had been displayed.



## 8 Photographs

### 8.1 Equivalent isotropically radiated power Test Setup



### 8.2 Unwanted emissions in the spurious domain Test Setup

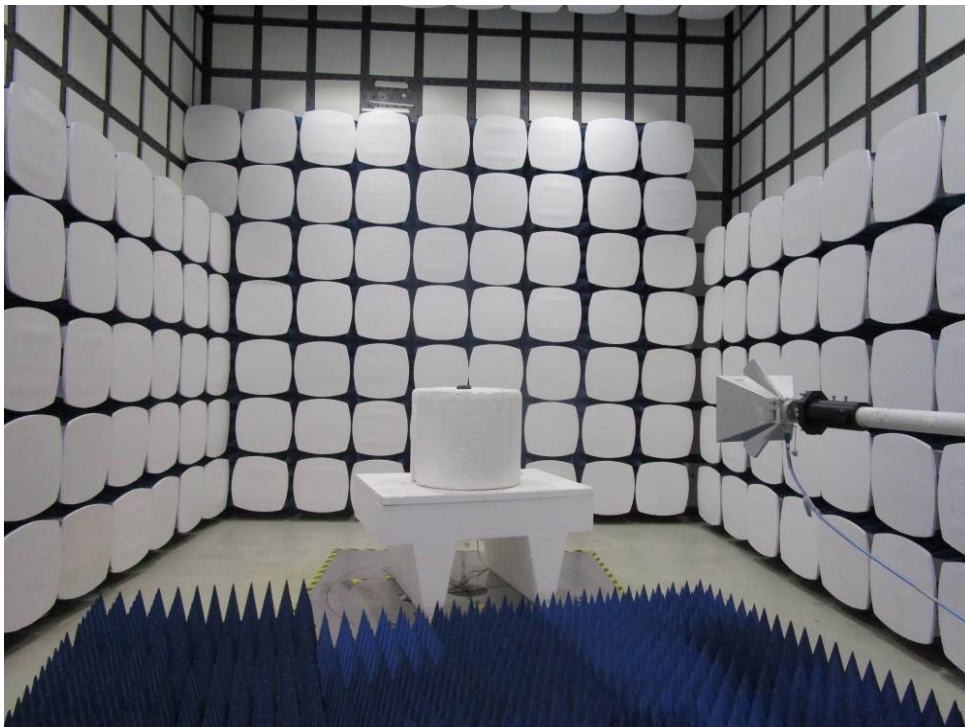

### 8.3 Spurious Emission Test Setup



### 8.4 EUT Constructional Details (EUT Photos)

Refer to Appendix A - Photographs of EUT Constructional Details for SZEM1804003461CR.

## 9 Appendix

### 9.1 Appendix 300440

#### 1. -6dB Bandwidth

Mode	Channel (Frequency)	-6dB Bandwidth(MHz)	Requirement (MHz)	Conclusion
GFSK	L	0.700	≤20MHz	N/A
	M	1.320	≤20MHz	N/A
	H	0.980	≤20MHz	N/A

#### 2. Equivalent Isotropically Radiated Power

Test Conditions		Mode	Channel (Frequency)	EIRP Value (dBm)	Limit (dBm)	Result
Temp (°C)/ Volt (V DC)						
TNVN	GFSK	L	-2.47	10	PASS	
		M	-1.85	10	PASS	
		H	-10.53	10	PASS	
VLTL	GFSK	L	-2.53	10	PASS	
		M	-1.93	10	PASS	
		H	-10.88	10	PASS	
VHTL	GFSK	L	-2.51	10	PASS	
		M	-1.97	10	PASS	
		H	-10.87	10	PASS	
VLTH	GFSK	L	-2.53	10	PASS	
		M	-1.89	10	PASS	
		H	-10.81	10	PASS	
VHTH	GFSK	L	-2.46	10	PASS	
		M	-1.93	10	PASS	
		H	-10.84	10	PASS	

**Remark:** EIRP= Read EIRP value (dBm) + 10 log (1/x)

X=duty cycle

**3. Permitted Range of Operating Frequencies**

Test Conditions	Mode	CH(Frequency)	Result(MHz)	Limit (MHz)	Conclusion
Temp (°C)/ Volt (V DC)					
VNTN	GFSK	L	2406.86	>2400	PASS
		H	2475.89	<2483.5	PASS
VLTL	GFSK	L	2406.92	>2400	PASS
		H	2475.86	<2483.5	PASS
VLTH	GFSK	L	2406.81	>2400	PASS
		H	2475.91	<2483.5	PASS
VHTL	GFSK	L	2406.93	>2400	PASS
		H	2475.77	<2483.5	PASS
VHTH	GFSK	L	2406.81	>2400	PASS
		H	2475.83	<2483.5	PASS

- End of the Report -